



Sol-Ark 8K Install Guide & Owner’s Manual

INSTALL GUIDE 1-24

TABLE OF CONTENTS	1
DISCLAIMER	2
COMPONENT GUIDE	3
SYSTEM PLACEMENT	4
TRANSFER SWITCH	5
MOUNTING	6
BATTERY WIRING	7-8
SOLAR PANEL WIRING	9-10
SYSTEM WIRE DIAGRAM	11
LARGE GENERATOR EXAMPLE DIAGRAM	12
BACKUP GAS GENERATOR SETUP	13
SENSOR PLACEMENT & TESTING	13
BATTERY SETTINGS AND <u>WIFI SETUP</u>	14-20
EMP SUPPRESSOR INSTALLATION	20
RAPID SHUTDOWN DIAGRAMS	21
SPECIFICATIONS	22
OFF GRID TIPS & GRID TIE / NO BATT TIPS	23
POWERING ON THE SYSTEM / INDICATOR LEDs	24
SELECTING POWER MODES / SENSORS	24-25
BATTERY SETTING & LIMITER SENSOR AUTO-SETUP	26
SCREENS	27-31
BATTERY CHARGE/DISCHARGE REFERENCE	32
WARRANTY	33
TROUBLESHOOTING GUIDE / ERROR CODES	34-36
COMMON BATTERY APPLICATION NOTE	37
WIRE GAUGE GUIDE	38
INSTALL TESTING CHECKLIST	39-40

CONTACT US

PHONE	1-972-575-8875
EMAIL	SALES@SOL-ARK.COM
WEBSITE	WWW.SOL-ARK.COM



Disclaimer

UNLESS SPECIFICALLY AGREED TO IN WRITING, SOL-ARK:

(a) MAKES NO WARRANTY AS TO THE ACCURACY, SUFFICIENCY OR SUITABILITY OF ANY TECHNICAL OR OTHER INFORMATION PROVIDED IN ITS MANUALS OR OTHER DOCUMENTATION.

(b) ASSUMES NO RESPONSIBILITY OR LIABILITY FOR LOSS OR DAMAGE, WHETHER DIRECT, INDIRECT, CONSEQUENTIAL OR INCIDENTAL, WHICH MIGHT ARISE OUT OF THE USE OF SUCH INFORMATION. THE USE OF ANY SUCH INFORMATION WILL BE ENTIRELY AT THE USER'S RISK.

Sol-Ark cannot be responsible for system failure, damages, or injury resulting from improper installation of their products.

Information included in this manual is subject to change without notice.

Sol-Ark 8K inverter should be installed by qualified persons only.



Do Not Mount Outdoors

Do Not Expose to Moisture

System Must Have Ground

System Must Have Neutral

Solar PV+/PV- Are Ungrounded

Ground Must be Bonded to

Neutral Once in Home

1. Inspect Shipment

- a. Compare the package condition to the condition of the package in the photo we sent you before it left our facility. **You must note any damage due to shipping with delivery driver before accepting the package otherwise the shipping company will deny any claim.**
- b. If damaged, contact us immediately at 972-575-8875 Ext. 3

2. Component Guide

- a. Solar Panel MC4 tool: To disconnect solar panels
- b. Battery Resistor: To connect batteries for the first time
- c. WIFI Plug: For software updates and remote monitoring (You will receive **ONLY ONE** of two **types of** WIFI plug, not both, picture indicates what the plugs look like)
- d. Limiter Sensors: for “Limited-to-Home Mode”
- e. French Cleat: For wall mounting the Sol-Ark 8K
- f. Battery Temperature Sensor: For voltage adjustment
- g. Battery Cables (If purchased)
- h. Solar Panel Wire 100’ (If purchased)
- i. Solar Panel Jumper wires 25’ (If purchased)
- j. Y-Connectors (If purchased)
- k. Battery Toroids: For EMI reduction

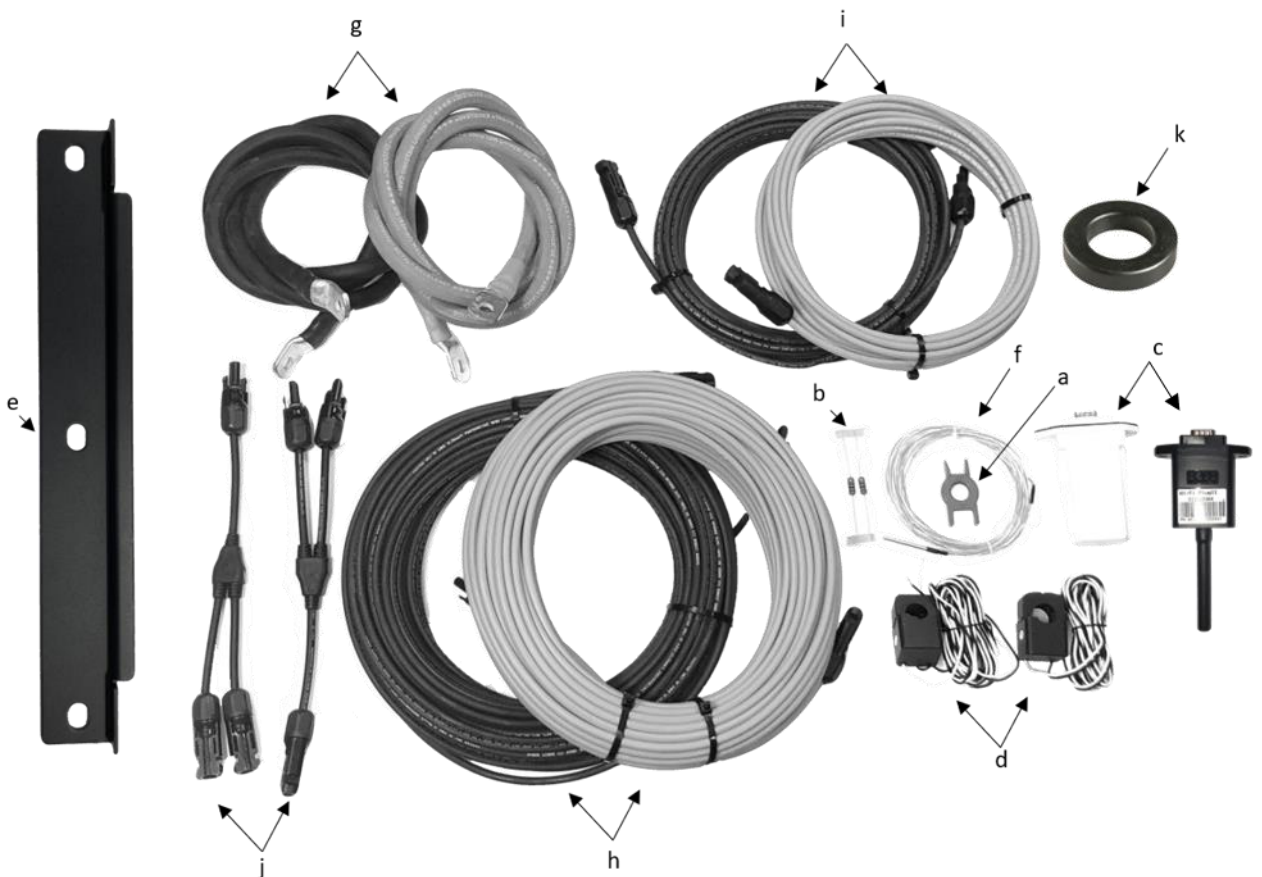

3. Component Distance Guide

WIRE RUN LENGTH: SEE DIAGRAM FOR WIRE GAUGE (AWG) RECOMMENDATIONS, PAGE 11 FOR COMPLETE DETAIL

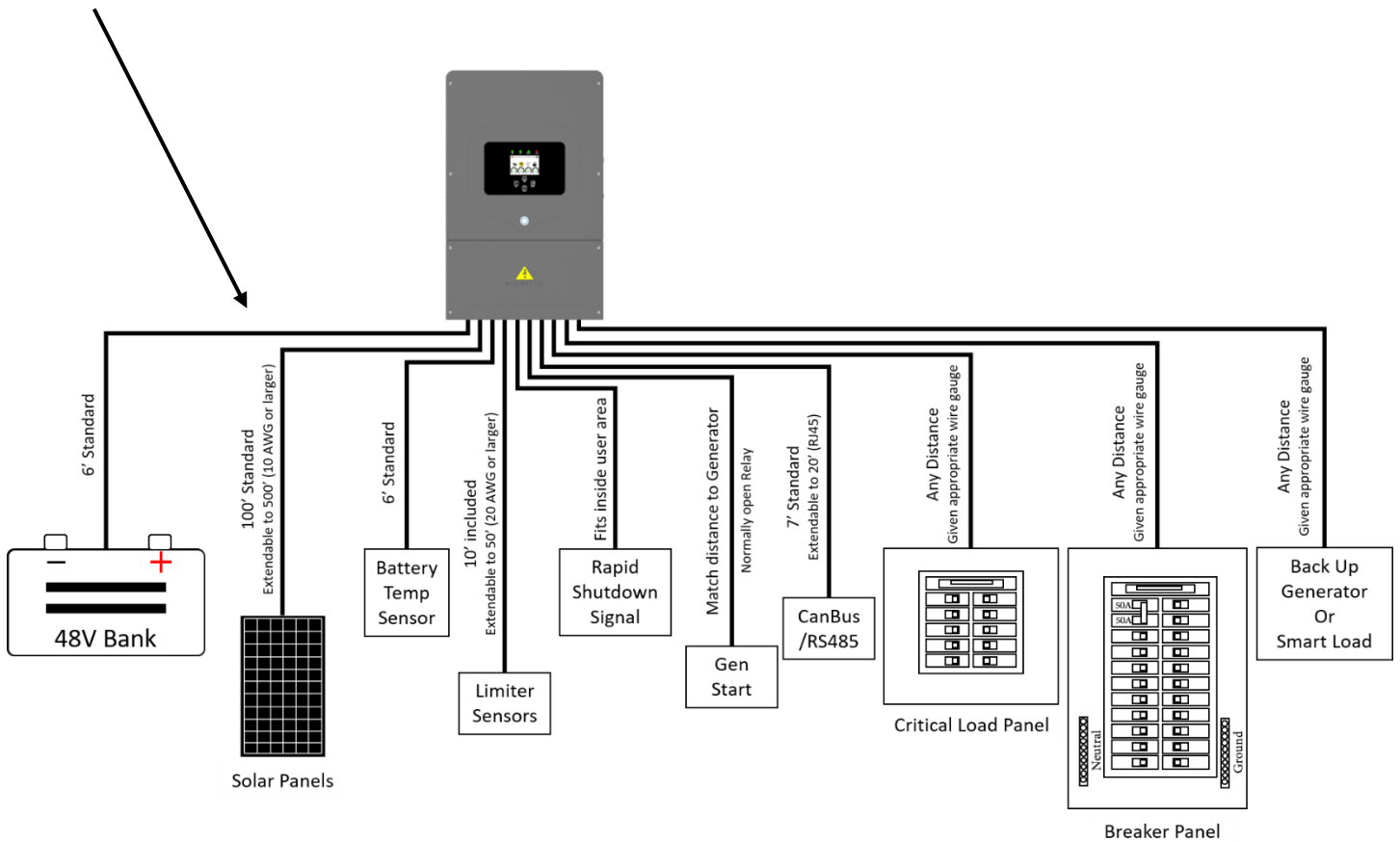

IF PROGRAMMED TO SMART LOAD
DO NOT CONNECT GENERATOR TO GEN PORT

4. Decide Critical Backup Circuits

- a. Decide which 10 circuits will be on backup power continuously. These circuits **must use non-GFI breakers** to work with the transfer switch. You can replace a GFI breaker with a normal breaker, installing GFI outlets instead (or you can move GFI breaker into 10-circuit SW). If applicable, low load circuits can be combined.
- b. **Important: Make sure to keep** within inverter amperage limits:
 On Grid = 50A continuous
 Off Grid = 33A continuous/83A peak
- c. Verify each load circuit by measuring typical and max Amps with a clip-on Amp meter. Amps x 120V = Watts

5. Mount Transfer Switch

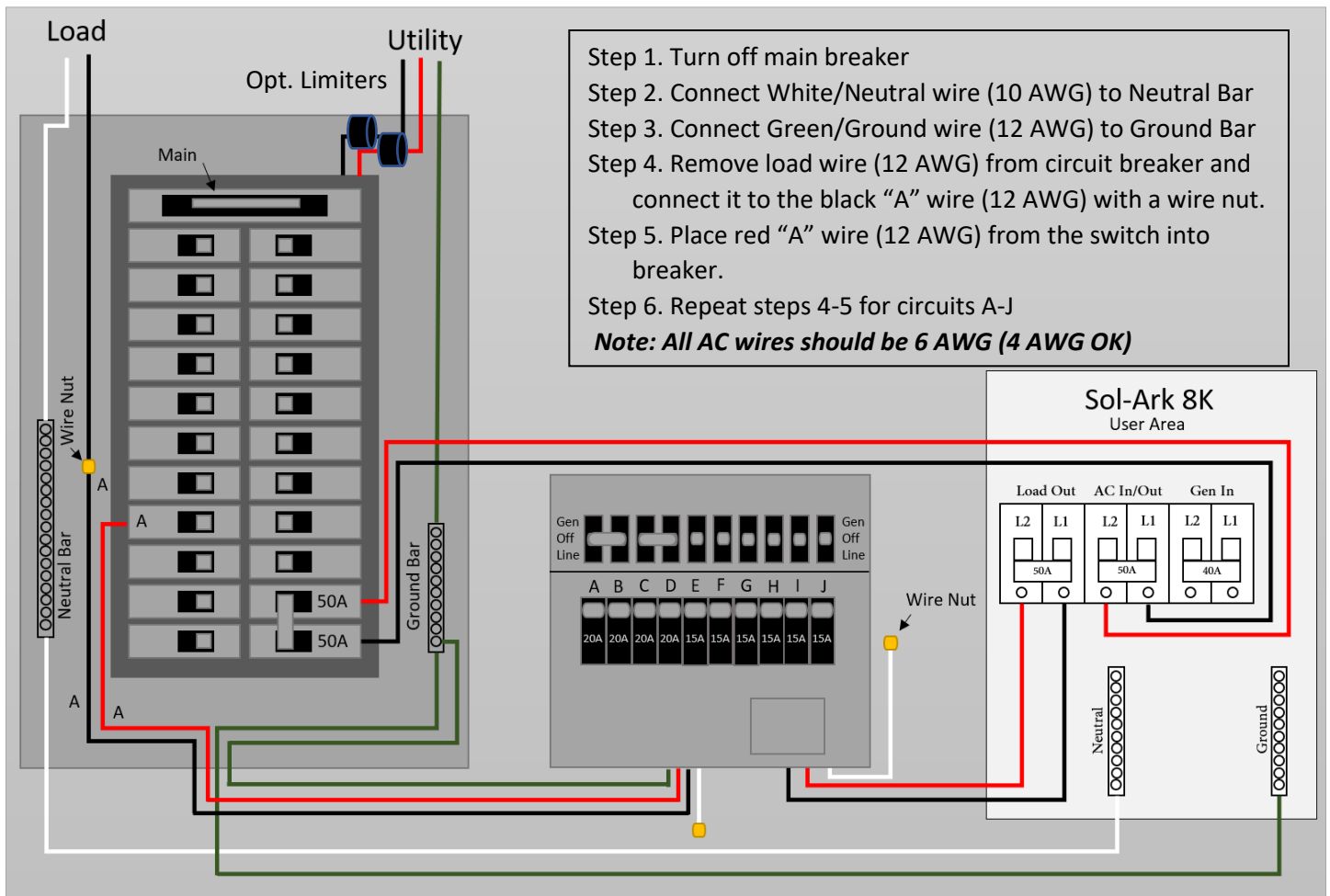

Important notes:

When the transfer switch is in the "Gen" position, this means the circuit is being powered by the Sol-Ark (which can use Grid/Solar/Battery/Generator automatically).

When in the "Line" position, the transfer switch is being powered by the grid (Sol-Ark can be removed).

The transfer switch setup is complete once all the switches are set to "Gen" position.

The Sol-Ark will take care of the rest.

If you are not installing a transfer switch (Off Grid or have a 50A sub-load panel), you can wire the "Load" output of the Sol-Ark 8K directly to a Main Lug breakers sub-panel rated for at least 50A.

Please refer to page 11 for complete wire diagram



Strain Reliefs must be used for all wires going in/out of the Sol-Ark 8K user area

Ground and Neutral must be wired as shown above, or damage will occur.

Conduit (or double insulated wire) must be used for the AC Wires going to and from the Sol-Ark.

DO NOT CONNECT THE GRID TO THE LOAD OUTPUT BREAKER

6. Install Double Pole 50A breaker in Main Panel for Grid In/Out

- a. It is best practice to install at the opposite end of the bus bar from the main breaker (Usually this is the bottom of the breaker panel as seen on page 5).

7. Mount Sol-Ark 8K

- a. Find a suitable location for the system, keeping in mind the dimensions in Fig. 1 below.
- b. System must be protected from moisture and extreme heat. **(Do not mount outdoors or in attic OR WARRANTY WILL BE VOID AND DAMAGE WILL LIKELY OCCUR)**
- c. The system weighs 75lbs (34kg), be sure to attach it securely to the wall. You may need to affix a mounting board to your wall first using 6-8 screws into studs.
- d. Then use 2-3 screws (appropriate in length and type for your mounting surface) to mount the French Cleat to the board/wall (washers recommended).
- e. Mount the Sol-Ark on the installed cleat making sure that it sits properly and is level.
- f. Add 2 screws in bottom mounts.

Fig. 1

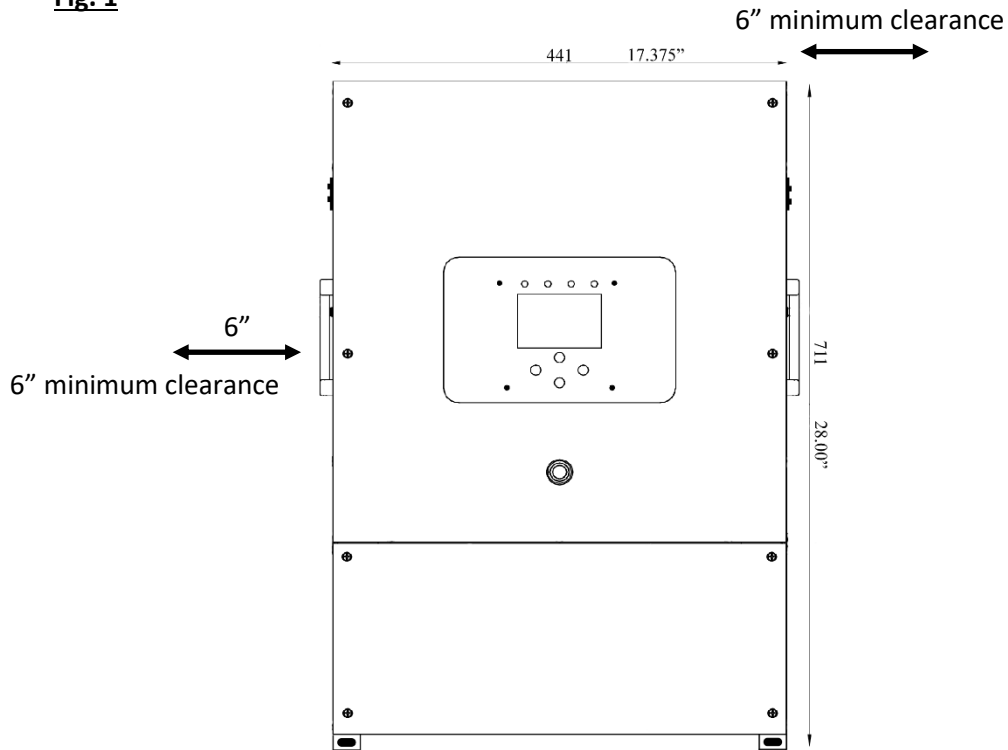

8. Connect Batteries (Sol-Ark should be POWERED “OFF”)

a. Connect the batteries to the Sol-Ark 8K as shown in the diagrams **Fig. B** below:

b. Fig. A: Install included ferrites (**part k. on pg. 3**) on the battery input cables. Slide the ferrite over the battery cables so that both cables are within the toroid (as shown in Fig. A).

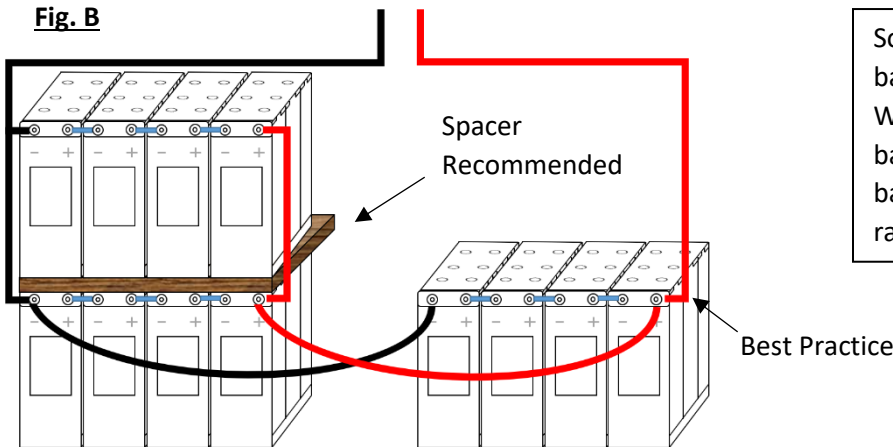

Fig. A

i. The toroid usually fits inside the user area of the Sol-Ark.

c. When connecting for 1st time, use included 100ohm resistor (**part b. on pg. 3**) to pre-charge the inverter for 30s before connecting 6ft cable to Sol-Ark (**see Fig. D**).

i. Hold the resistor so that it contacts the free battery cable and the battery terminal, completing the circuit (see below). This can be done with small clamps or by hand.



Note: PCC batteries are stackable

Sol-Ark 8K is a **48V** system. Do not wire the battery bank to any other nominal voltage. When using 12V batteries do not exceed 4 batteries in series. When using other battery chemistries, stay within the voltage range: Min 41V-Max 59V

WARNING! Do not stack more than 2 banks high!

Fig. C

**Do NOT reverse polarity of batteries!
Damage will occur!**

Fig. D

Use included resistor to charge capacitors when connecting batteries for the first time. Hold for 30 seconds.

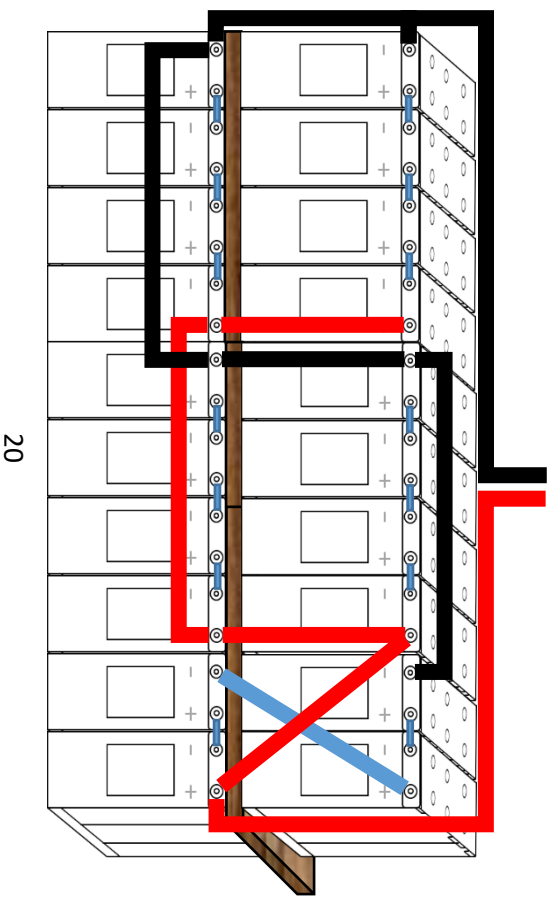
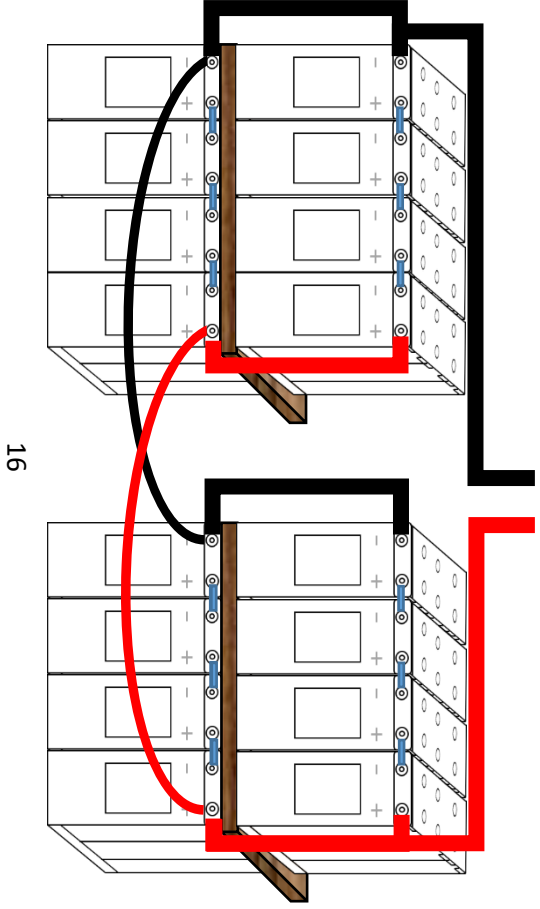
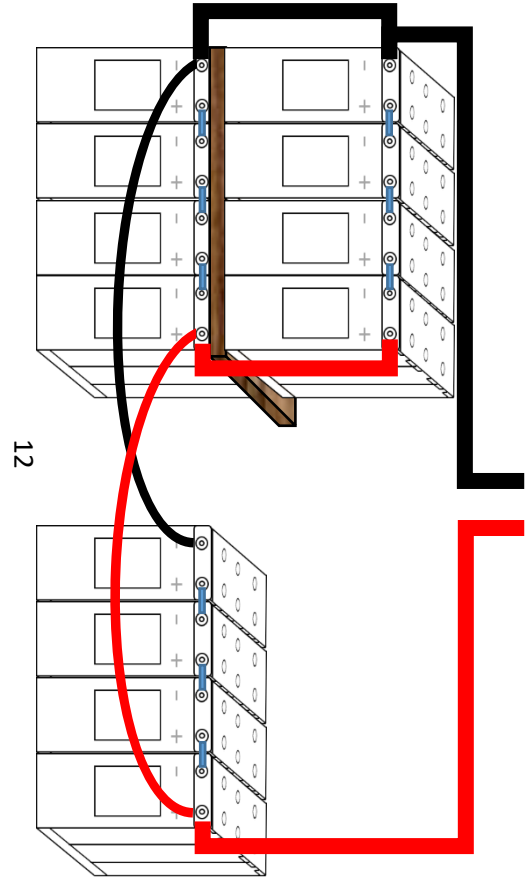
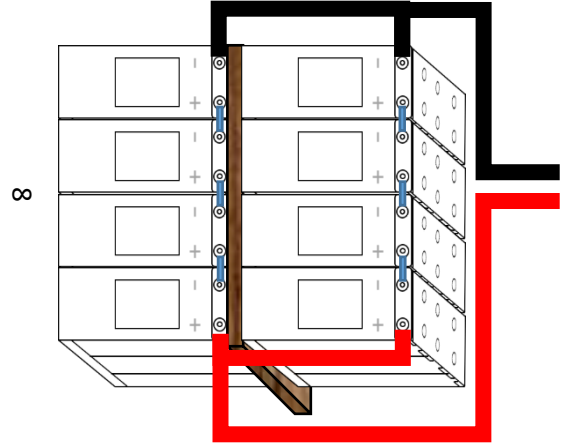
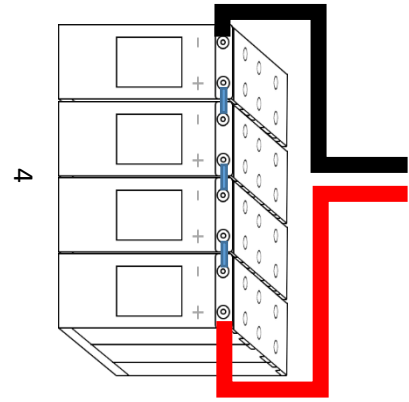

9. Solar Panel Install

1. Sol-Ark 8K has 2 separate pairs of solar panel inputs.

(Dual MPPT)

2. Use the chart to the right to determine how many strings of panels and how many panels per string can be installed. This chart is only a guide, other panel types and configurations can be compatible if within system specifications.

3. Max PV input:

11,000W(+/- 5%) per system (6,000W per MPPT) PV = 500Voc Max

Note: Damage will occur if PV Voc > 550V.

4. Connect the strings of solar panels to the system as shown on pages 9/10.

5. Each pair of strings, PV1A/B and PV2A/B, must be the same voltage if both are used (see Fig. E).

6. Panel frame grounding can be done to any ground in the home via 12AWG wire. Mounts usually bond frames together, so only 1 ground wire is needed.

Note: Max Panels in Series:

60 Cell: 10

72 Cell: 9

96 Cell: 5

 **60-72 Cell 280W-315W panels assumed for this guide. Please check your panel datasheet to confirm Voc rating!!**

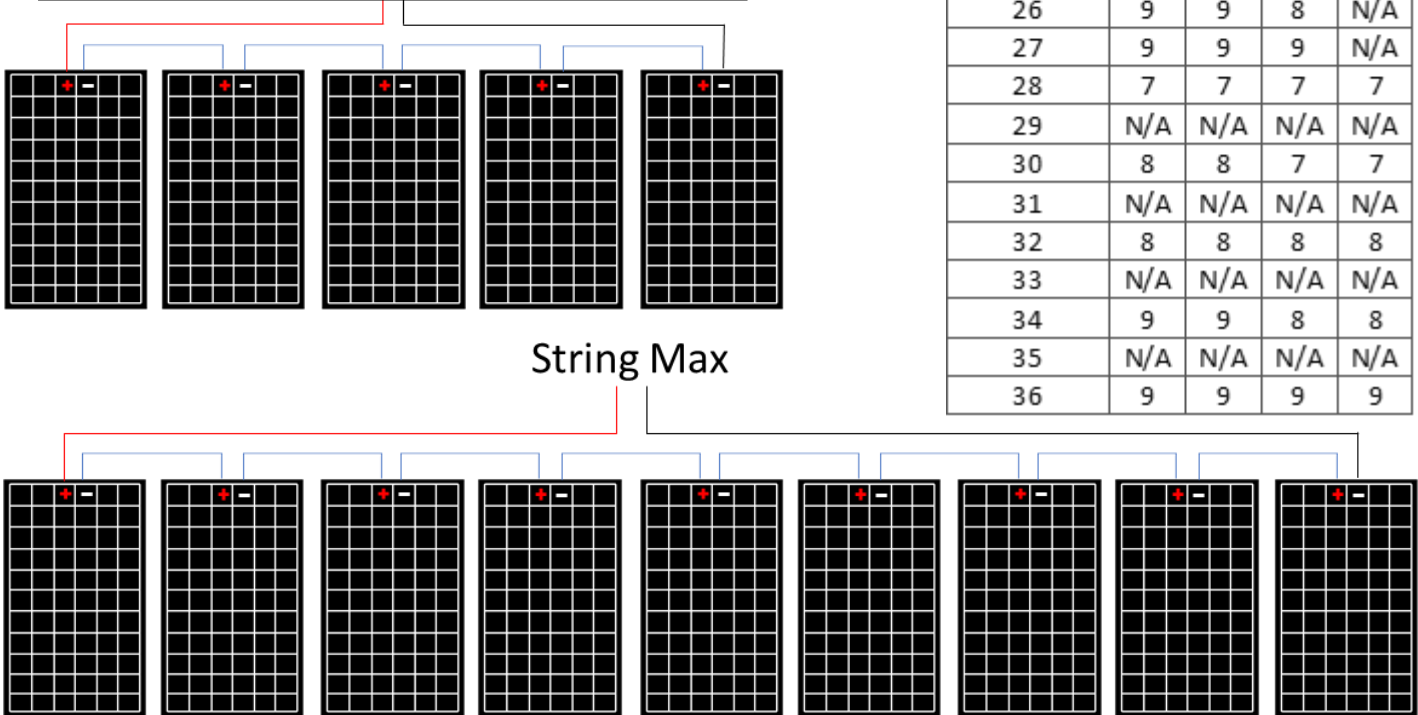
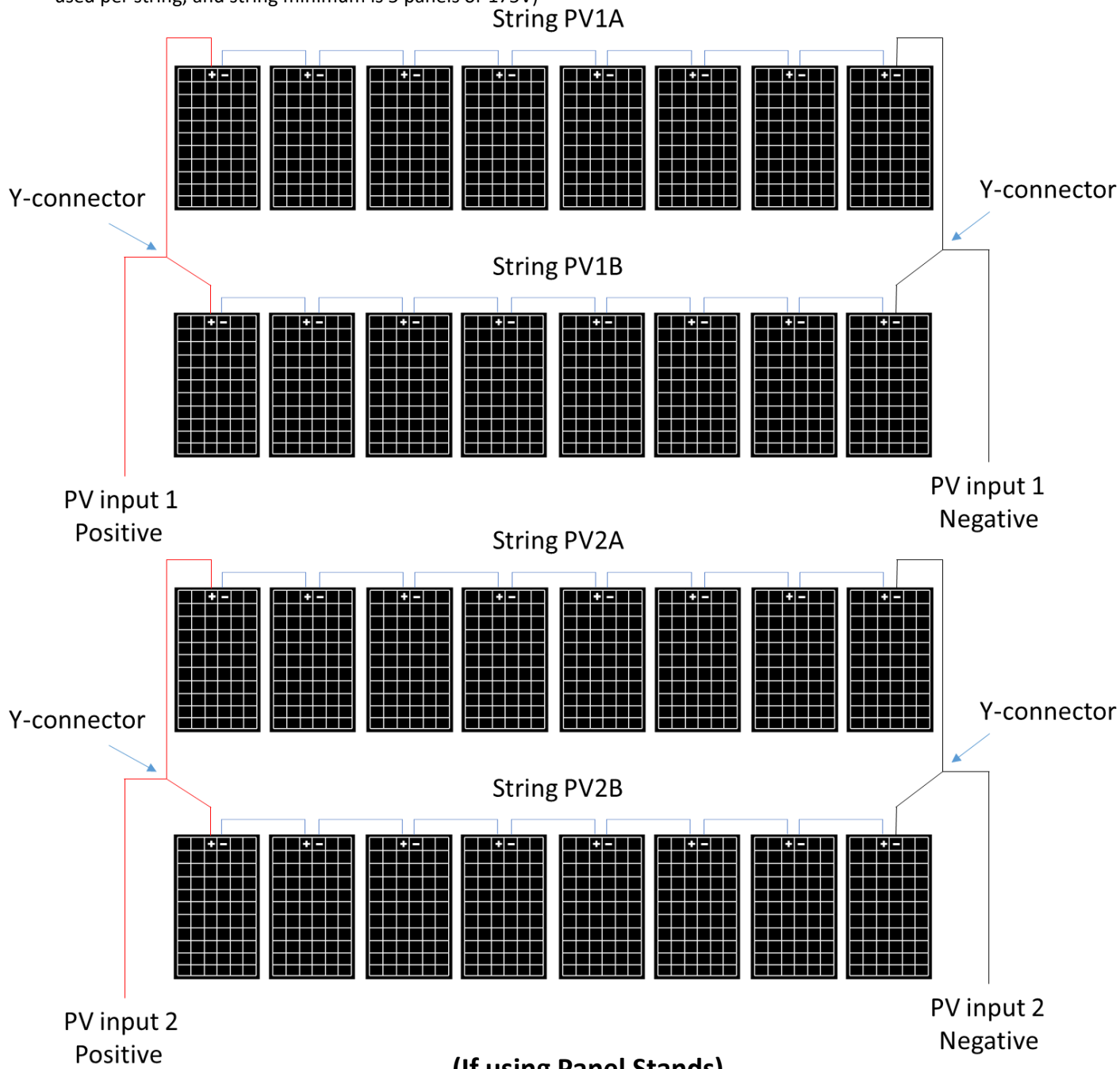

Fig. E: Suggested Solar Panel String Guide

(60 or 72 cell Panels, 305W/Panel or less)

Total Panels	PV1A	PV1B	PV2A	PV2B
1	N/A	N/A	N/A	N/A
2	N/A	N/A	N/A	N/A
3	N/A	N/A	N/A	N/A
4	N/A	N/A	N/A	N/A
5	5	N/A	N/A	N/A
6	6	N/A	N/A	N/A
7	7	N/A	N/A	N/A
8	8	N/A	N/A	N/A
9	9	N/A	N/A	N/A
10	5	5	N/A	N/A
11	6	N/A	5	N/A
12	6	6	N/A	N/A
13	7	N/A	6	N/A
14	7	7	N/A	N/A
15	8	N/A	7	N/A
16	8	8	N/A	N/A
17	9	N/A	8	N/A
18	9	9	N/A	N/A
19	6	6	7	N/A
20	7	7	6	N/A
21	7	7	7	N/A
22	7	7	8	N/A
23	8	8	7	N/A
24	8	8	8	N/A
25	8	8	9	N/A
26	9	9	8	N/A
27	9	9	9	N/A
28	7	7	7	7
29	N/A	N/A	N/A	N/A
30	8	8	7	7
31	N/A	N/A	N/A	N/A
32	8	8	8	8
33	N/A	N/A	N/A	N/A
34	9	9	8	8
35	N/A	N/A	N/A	N/A
36	9	9	9	9

If using Y-Connectors: (Running two strings in parallel, totaling 18A (self-limiting) Note: separate wires can be used per string, and string minimum is 5 panels or 175V)



(If using Panel Stands)

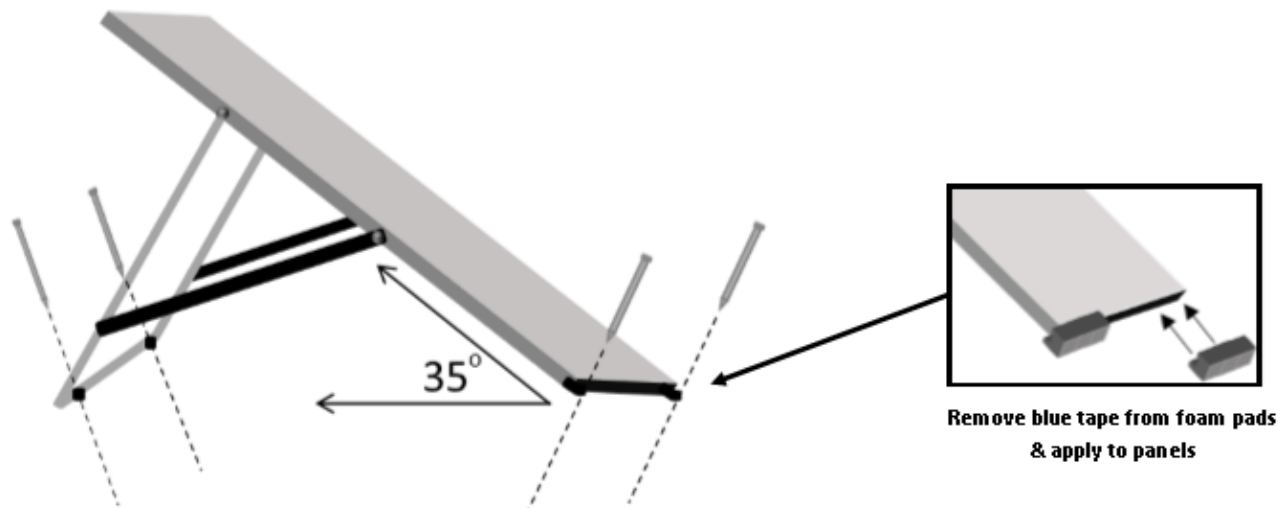

Portable Generator / AC Coupling / SmartLoad Diagram

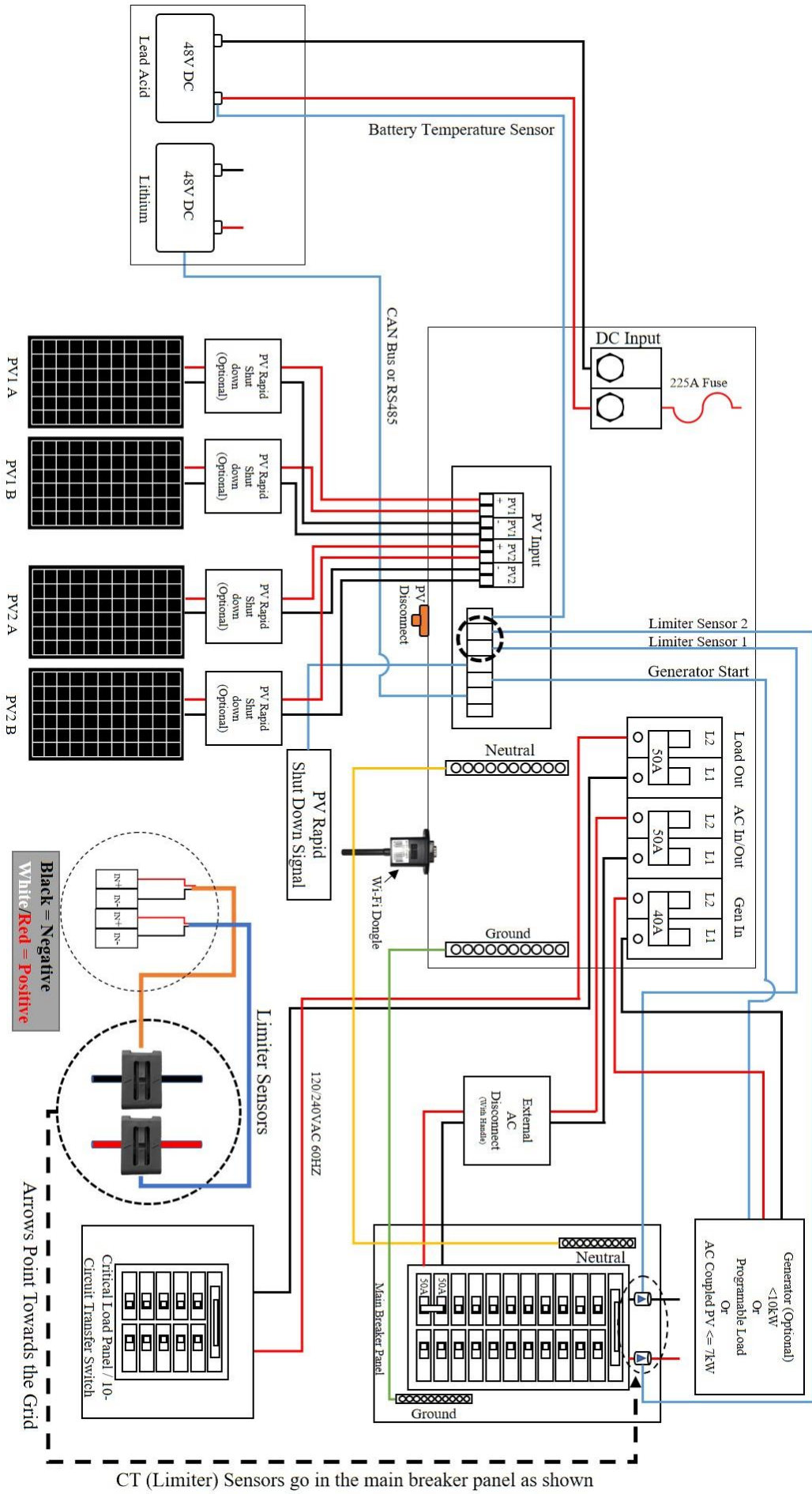

CT (Limiter) Sensors go in the main breaker panel as shown

August 3, 2019

Standard Install Diagram

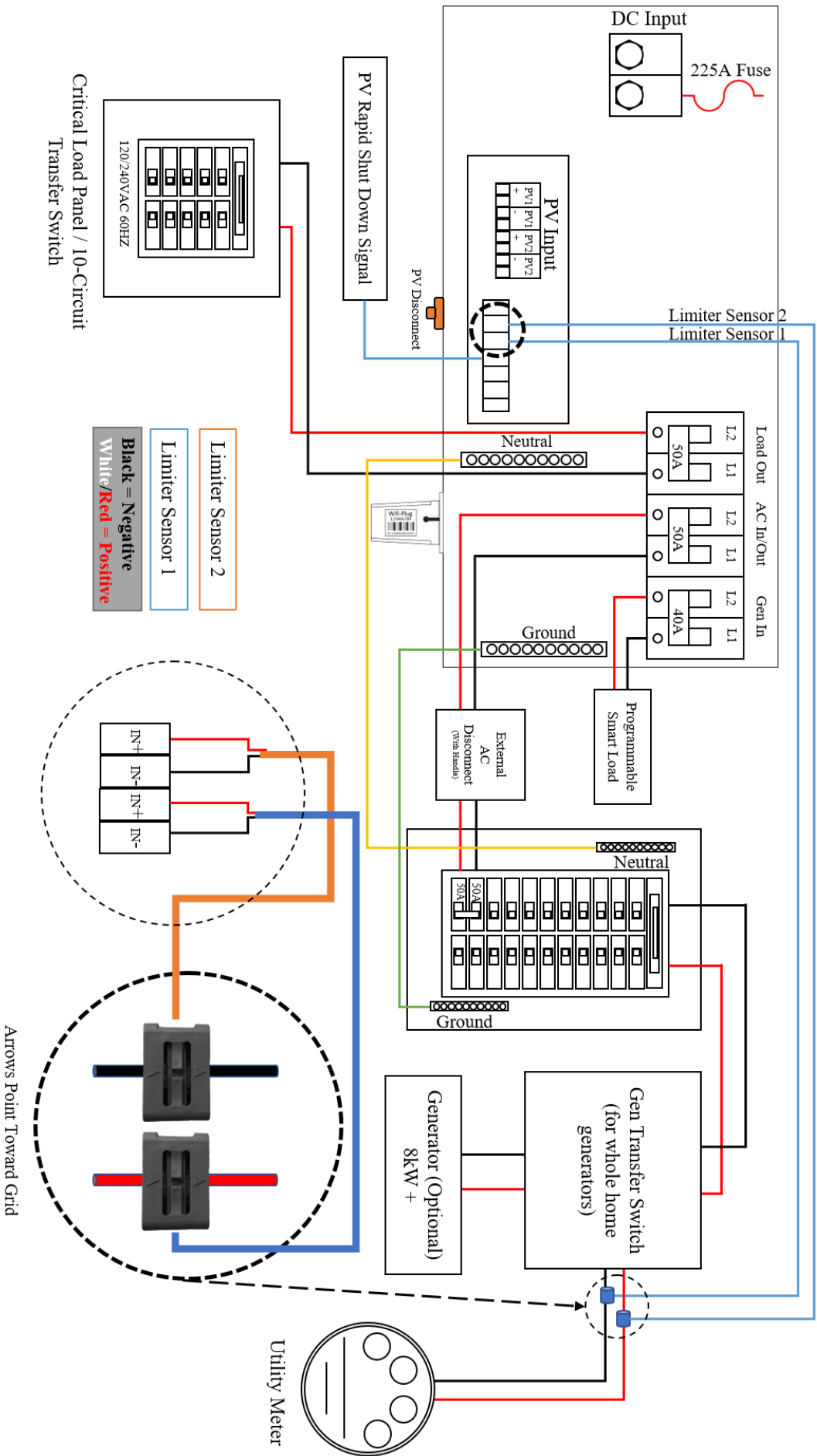

August 3, 2019

10. Connecting a Portable Backup Generator (240V only)

- a. Generators smaller than 10kW - See page 11
 - i. Connect the generator output to the “Gen” input breaker in the Sol-Ark 8K user panel.
 - ii. Only 240V generators are supported.
 - iii. If **Off-Grid** connect the generator output to the “Grid” input in the Sol-Ark and select the “GEN connected to Grid input” option in the Sell Control tab of the Grid Setup Menu.
 1. Home Screen → Gear Icon → Grid Setup → Sell Control
- b. Standby Generators >10kW - See page 12
 - i. If **Off-Grid**, you may connect the generator output directly to the “Grid” input on the Sol-Ark 8K. The Sol-Ark 8K will perceive the generator as if it were the grid. You will need to select the “GEN connected to Grid input” option in the Sell Control tab of the Grid Setup Menu.
 1. Home Screen → Gear Icon → Grid Setup → Sell Control
 - ii. Being **Off-Grid**, you will have “Grid Sell Off” and without the need for current limiting sensors.
 - iii. Under “Grid Setup” do the following:
 1. Select “Limited to Load”
 2. Select “General Standard”
 3. Increase Grid frequency range: 53-65Hz
 - iv. “Limited To Home” mode works well with generators.

If using a large generator with a whole home transfer switch, we suggest not using the “Gen” input breakers in the Sol-Ark. Instead, use the existing home wiring to distribute the generator’s power (through your existing “Gen” transfer switch, usually to the main panel in the home or building).

11. Sensor and Accessory Placement

- a. Limiter Sensors
 - i. Install on incoming electrical service wires on L1 and L2 (see diagram pg. 11). Required if selling power to whole home.
- b. Battery Temp Sensor
 - i. Place between batteries (**See Fig. F**). Note: Temp sensor is not required for lithium batteries.
- c. CanBus & RS485
 - i. In order to connect batteries to the Sol-Ark 8K via RJ45, you will need to splice the end that connects to the Sol-Ark 8K. Use the middle two conductors.
- d. Gen Start Signal
 - i. Normally open relay that closes when the Gen Start state is active
 - ii. If your generator only starts with the loss of 120/240V to the generator, we suggest using a DPST relay to the output of the inverter.
- e. PV Rapid Shutdown Signal
 - i. 12v signal/200mA power is present until the Sol-Ark is shut down with the front button
- f. WI-FI Antenna
 - i. Only needed for remote monitoring or software updates.

Fig. F

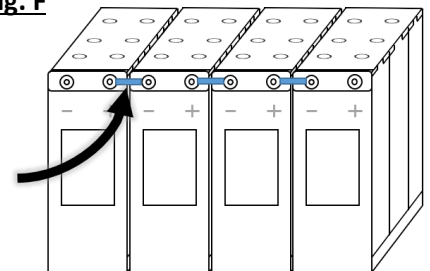

12. Testing and Powering up Sol-Ark 8K

- a. Check Voltage of each PV input circuit
 - i. Should be no higher than 500Vdc open circuit.
 - ii. DO NOT connect PV+ OR PV- to GND.
 - iii. Good to verify polarity.
- b. Check Grid Input Voltage (voltages shown are for North America)
 - i. Ensure 120Vac L1 to Neutral and L2 to Neutral.
 - ii. Ensure 240Vac L1 and L2.
 - iii. Check Neutral and Ground are ~0V AC.
- c. Check Battery voltage
 - i. Turn on battery switch (if using a Lithium battery).
 - ii. Voltage should be 45Vdc-57Vdc.
- d. If all checks out, Turn on Breakers for Grid and Load, Turn PV Disconnect knob to "On"
- e. System will boot up with power from PV, Grid, or ON/Off Batt.
- f. Press the ON/OFF Button on the front, light should come on.
- g. If you installed limit sensors for Limited To Home selling mode, it is critical you verify the proper sensor and direction. (if MCU SW = 1654 or higher, an auto learn function avoids all this).
 - i. Using AC multi-meter, verify L1 voltage on AC in/out is 0Vac with main L1 connection in panel. Same for L2.
 - ii. To verify sensor connections to Sol-Ark, try removing one sensor from the main L1 connection. The power should drop to 0W.
 - iii. To verify proper sensor direction, with any loads in the home, the HM: +watts will be positive. If you turn on solar panels and turn enable Grid Sell, you should see HM: -watts if you are producing more power than the loads are consuming. And if you turn on limited power to Home mode, then HM: ~0 watts to zero the meter (system matches the loads to within 99%).

13. Basic Setup

- a. Display: Auto dim must be enabled for LCD screen to be covered by warranty. Color LCD screens dim if left on continuously for years.
- b. Time: Set date and time for the system

14. Programming Battery Settings

- a. Battery Size
 - i. This allows Sol-Ark to know the size of the battery bank. The system is also self-learning as batteries age.
 - ii. Main Menu → System Settings → Battery Setup → Batt → Batt Capacity
- b. Use Battery Voltage or % Charged
 - i. Use whatever you are comfortable with. Most installers prefer voltage, while most homeowners prefer % Charged.
- c. Battery Charge & Discharge Current
 - i. For AGM and Flooded, we recommend Ah battery size x 20% = Charge/Discharge amps
 - ii. For Lithium, we recommend Ah battery size x 50% = Charge/Discharge amps
 - iii. For Gel, follow manufacturer's instructions.

iv. When Off Grid, discharge current is not limited. The inverter will always remain powered on.

d. Battery Type

- i. Navigate to the charge menu and set the values appropriate to your battery chemistry. The owner's manual is good reference for lead acid batteries.
- ii. Main Menu → System Settings → Battery Setup → Charge

Battery Type	Absorption Stage	Float Stage	Equalize Stage (every 90 days 3hr)
AGM (or PCC)	14.2v (56.8v)	13.4v (53.6v)	14.2v (56.8v)
Gel	14.1v (56.4v)	13.5v (54.0v)	
Wet	14.7v (59.0v)	13.7v (55.0v)	14.7v (59.0v)
Lithium	14.1v (58.0v)	13.2v (56.0v)	

Default

e. Battery Discharge

- i. Allows the user to define the depth of discharge the system will allow before using the grid/generator to the charge the battery bank. Solar is always the first priority in charging the battery bank.
- ii. Main Menu → System Settings → Battery Setup → Discharge

15. Grid Setup

- a. Grid Sell: maximum watts sold to grid
- b. Limited To Home: Limits power produced by the system to match the demand of the home
- c. Limited To Load: Limits power produced by the system to match the demand of connected loads

16. Remote Monitoring Setup (WIFI Setup Video: https://youtu.be/0H0OzfZz_kQ)

- a. WIFI (Via Cell Phone or computer)
 - i. Plug WIFI dongle into Sol-Ark
 - ii. If using a cell phone, turn off cellular
 - iii. Using your device look for WIFI networks and select the one that matches the PN number on your dongle
 - Password: 12345678 (Once Dongle is set up in this can be changed)
 - iv. Once connected, use a web browser to navigate to 192.168.8.66 (type it into the address bar) and log in
 - Username: admin (Once Dongle is set up in this can be changed)
 - Password: admin (Once Dongle is set up in this can be changed)
 - v. Once Connected to the Dongle

Once Connected, Dongle will have a solid green LED (Right) or all green LEDs (Left)

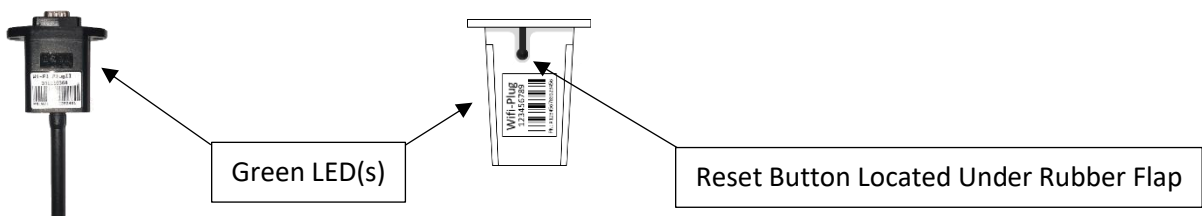

WI-FI Setup 3



Select Wi-Fi Configuration

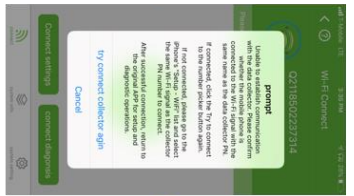

If you see this error refer to step 2

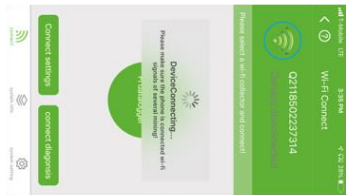

Once connected return to the app



Select Connect Wi-Fi datalogger



Select the Wi-Fi icon

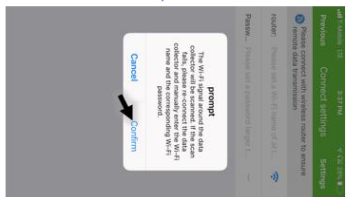

Select confirm

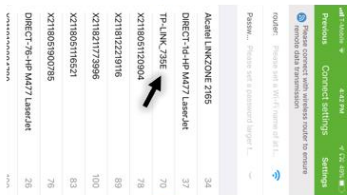

Select your Wi-Fi network



Enter password and Select 'settings'

Registration 4



Select Register



Select the "[i]" icon



Point your phone camera at the dongle barcode

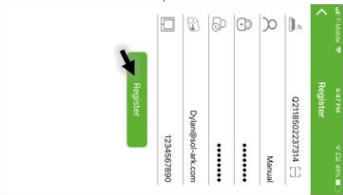

Enter information then select Register

When step 3 is complete all 4 of the lights on the dongle should be green (as seen here)



August 3, 2019

Log In & Basic Setup 5



Enter the credentials you registered with



Select your device



Select your PN #

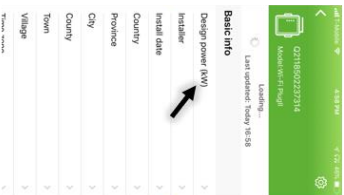

Select Design power



Enter the kW capacity of your install

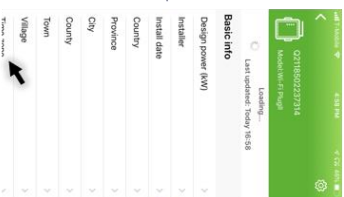

Select Time zone



Select your Time zone

Phone App Setup Instructions

1 Download the App



IOS Download Link



Android Download Link



WiFi Setup Video Link



App Walkthrough Video Link

Use a QR code reader app to scan the link for your OS

2 Connect to dongle



Go to your phone settings



Select Wi-Fi settings



Select the network that matches the PN # on the dongle



Default Password: 12345678



Once connected Open the SmartESS App

PN Number

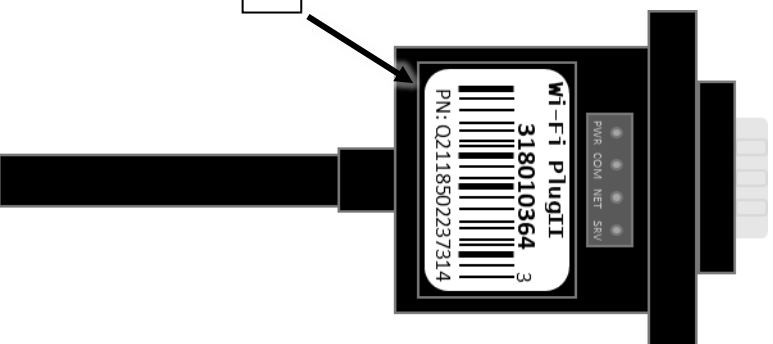

Manual Wi-Fi Setup without phone app (Skip if you used the phone app setup)

Log in to 192.168.8.66

Your password will be sent unencrypted.

Cancel
Log In

Username: admin Password: admin

中文
English

- 系统信息
- 无线终端设置
- 无线接入点设置
- 串口及其它设置
- 模块管理

系统信息

查看系统的参数信息及运行状态。

系统信息	
设备PN	X2118216909063
软件版本号	2.0.8.0
硬件版本号	2.0.1.0
MAC地址	F0:FE:6B:D8:ED:48

无线连接状态	
网络连接状态	No router
路由器SSID	wifi_test
IP地址	0.0.0.0

设备连接状态	
设备上联数	1
带数	1
协议代码	0200,1,1,#0#

Select "English"

中文
English

- System Info
- STA Interface Setting
- AP Interface Setting
- Application Setting
- Device Management

System Info

View the system parameter information and operating status.

System Info	
Device PN	X2118216909063
Software Version	2.0.8.0
Hardware Version	2.0.1.0
MAC	F0:FE:6B:D8:ED:48

STA Link Status	
Net Status	No router
Router SSID	wifi_test
IP	0.0.0.0

Device Link Status	
Device Online Num	1
Load Count	1
Device coding	0200,1,1,#0#

Select: "STA Interface Setting"

中文
English

- System Info
- STA Interface Setting
- AP Interface Setting
- Application Setting
- Device Management

STA Interface Setting

You could configure STA interface parameters here.

STA Interface Parameters	
AP's SSID	wifi_test Search...
加密模式	WPA2PSK
Encryption Type	AES
Pass Phrase	87654321

WAN Connection Type: DHCP(Auto config)

DHCP Mode	
Hostname(Optional)	HF-A21

Select: "Search"
If Network Password: Enter it here and Apply

Site Survey							
BSSID	RSSI	Channel	Encryption	Authentication	Network Type		
<input type="radio"/>	HawkLand1	70:5a:9e:74:fc:ba	0%	1	AES	WPA2PSK	Infrastructure
<input type="radio"/>	Cash	60:38:e0:6f:b5:60	39%	9	AES	WPA2PSK	Infrastructure
<input type="radio"/>	TP-LINK_735E	a4:2b:b0:ad:73:5e	100%	10	AES	WPA2PSK	Infrastructure
<input type="radio"/>	DIRECT-1d-HP M477 LaserJet	92:cd:b6:16:71:1d	81%	10	AES	WPA2PSK	Infrastructure
<input type="radio"/>	J&S Rentals	94:10:3e:87:e9:4e	0%	11	AES	WPA2PSK	Infrastructure
<input type="radio"/>	HP-Print-9B-Officejet 4630	58:20:b1:3d:72:9b	0%	11	AES	WPA2PSK	Infrastructure
<input type="radio"/>	TLS Landscape	30:f7:72:95:5b:ed	37%	11	AES	WPA2PSK	Infrastructure

Apply
Refresh

Select Your Network Then Apply

中文
English

- System Info
- STA Interface Setting
- AP Interface Setting
- Application Setting
- Device Management

Device Management

You may configure administrator account and password, load default setting or update firmware.

Administrator Settings	
Account	admin
Password	admin

Restart Module

Restart Module	Restart
----------------	---------

Load Factory Defaults

Load Default Button	Load Default
---------------------	--------------

Select: "Device Management"
Then Restart Dongle

Note: If you setup a new password for your WIFI, the first character of the password must be either 0-9 or A-Z and "=" is not supported.

Manual Wi-Fi Setup without Phone App (Skip if you used the phone app setup)

b. Phone App

- i. iOS Download Link: <https://itunes.apple.com/US/app/id1334656760?mt=8>
- ii. Android Download Link: https://play.google.com/store/apps/details?id=com.eybond.smartclient&hl=en_US



iOS Download Link



Android Download Link

a. Registering WIFI (Via Cell Phone or computer)

- i. Using the browser on your device that is connected to the internet, navigate to:
 - <http://www.dessmonitor.com/>
- ii. In the upper right-hand corner use the dropdown menu to select English
- iii. Then select “Register immediately”
 - Fill in the credentials and make sure to remember or write down your login credentials

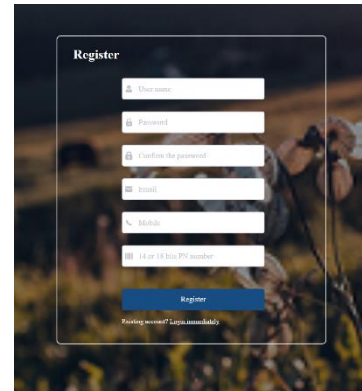
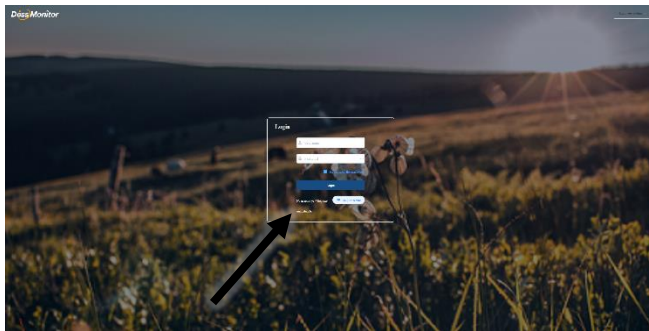

Note 1: The PN number is the number on the WIFI dongle that is connected to the Sol-Ark

Note 2: Registration of your system can also be done via the Smart ESS App

WIFI Troubleshooting:

- Light on the dongle won't turn green when connecting to WIFI:
 - If using a cell phone, make sure the cellular function is turned off.
 - Try turning off your local wireless router until you finish setup above.
 - You may need to reset your dongle (see below).
- Light on dongle is green but system cannot be seen by the application on PC or App.
 - Make sure your local wireless router that the Sol-Ark is connected to is connected to the internet.
- General troubleshooting techniques:
 - Make sure that the dongle is plugged in all the way.
 - Unplug the dongle and plug it back in.
 - Reset the dongle.
 - Uninstall phone app and reinstall.
- How to Reset the WIFI Dongle
 - While the dongle is plugged into the Sol-Ark and has power, press and hold the reset button for 10 seconds. The LED should turn red.
 - If Your dongle does not have a reset button, log into it and click "reset" under the device management tab.
- Which barcode should I scan when setting up the phone app?
 - The barcode on the WIFI dongle, not the QR code above
- I have tried everything, but it still won't connect.
 - Sometimes firewall settings on home routers will block traffic to the dongle, you may need to relax your firewall settings.

E.M.P Systems only:

Suppressor installation

- If your system was purchased with Lightning / EMP Hardening, the vast majority of protection is in the Sol-Ark. However, you also have EMP suppressors that get installed on the power cords of appliances that are connected to the transfer switch. Although not critical, it is recommended they be installed as close as possible to the appliance.
- You also have EMP suppressors that get installed on both solar panel wires with a zip tie. Closer to the panel is better. If you purchased the panels from us, we already installed >150kV/m protection inside the solar panels.



August 3, 2019

If using panels not
from Sol-Ark ²⁰

Rapid Shutdown Hardware Diagram (Midnight RSD per PV string)

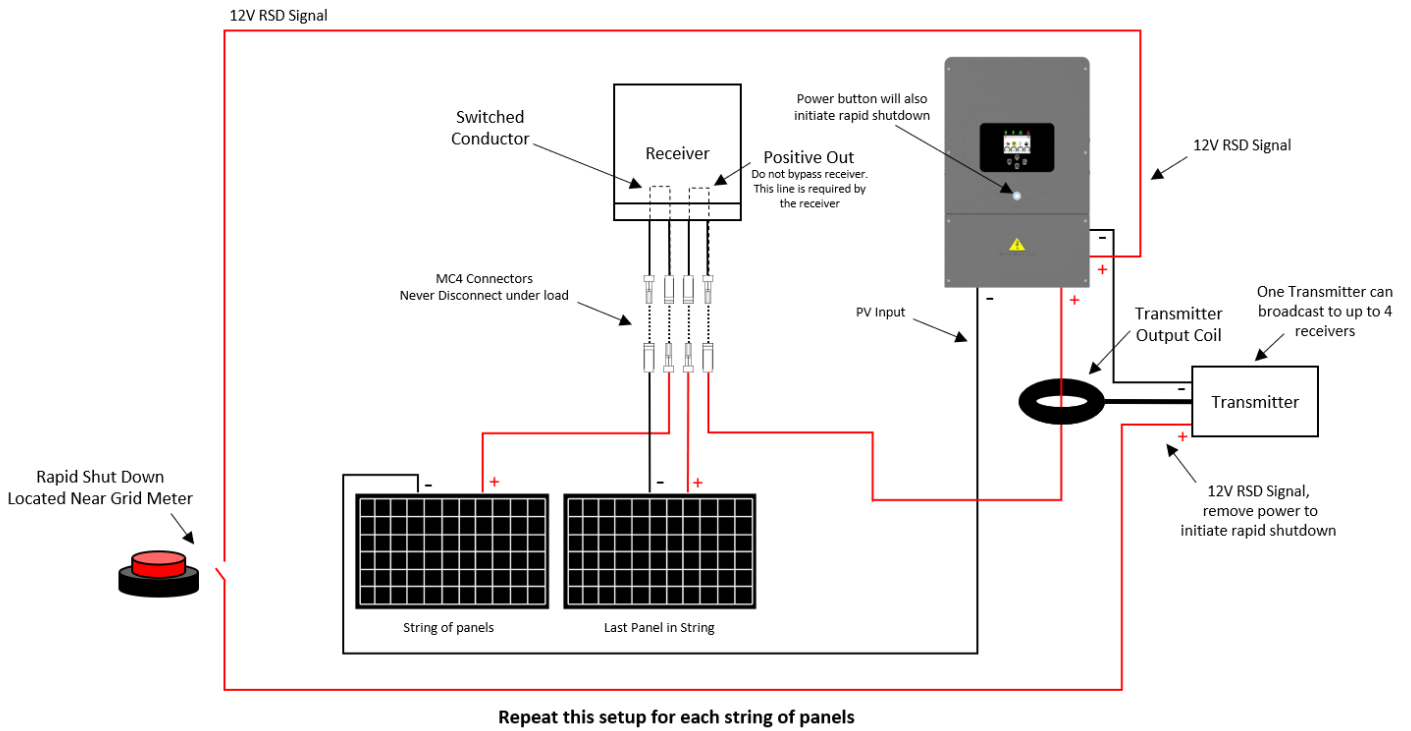

Note: Transmitter fits inside the user area of the Sol-Ark 8K

If String Level rapid shutdown is required for your install, each string of panels must have its own receiver module.

Rapid Shutdown Hardware Diagram (TIGO RSD per PV Module)

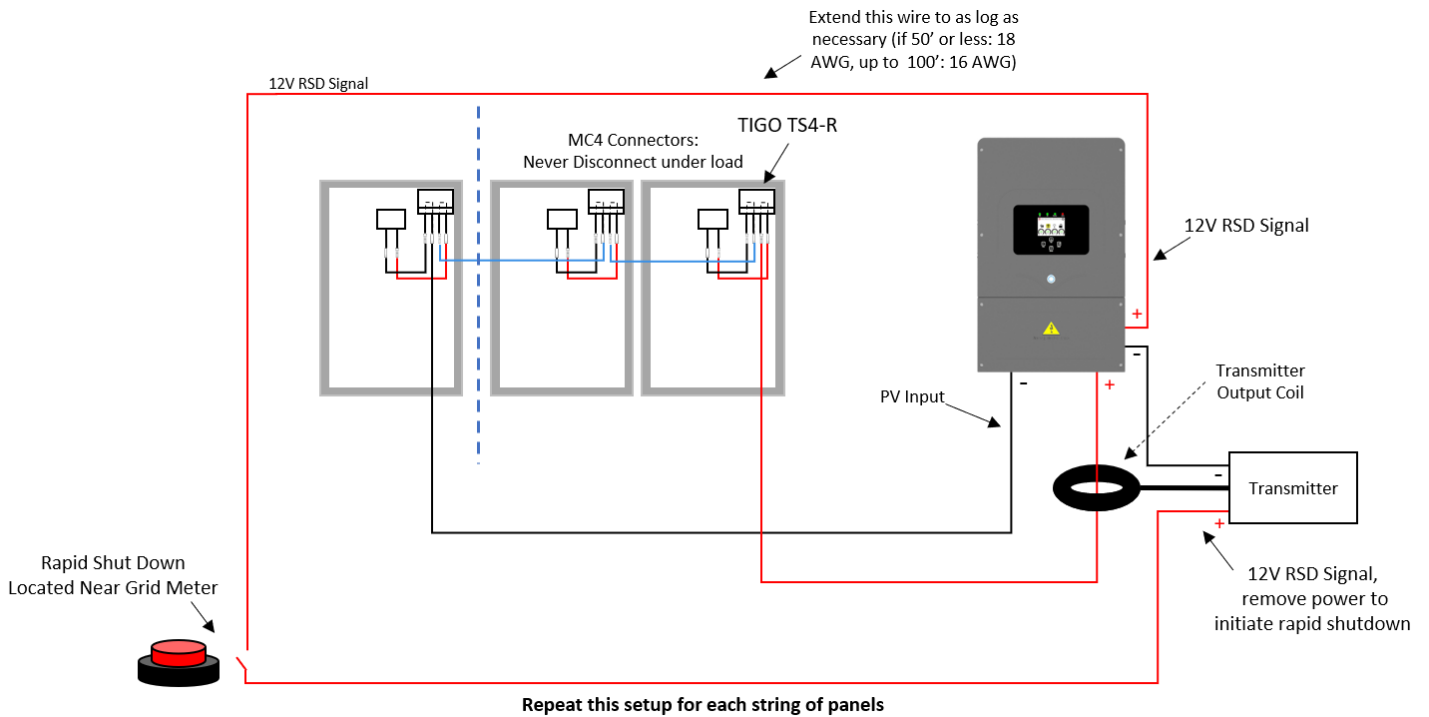

Sol-Ark-8K-48-ST Specifications

Solar	
Max allowed PV Power	11000W
Max allowed PV Power per MPPT	6000W
Max DC voltage	500V
MPPT voltage range	150-425V
Starting voltage	175V
Number of MPPT	2
Solar Strings per MPPT	2
Max DC current per MPPT	18A (self limiting)
Max AC Coupled Input (Micro/String Inverters)	7,000W
Max Combined Solar Input (DC+AC)	13,000W

AC Output	
Connections	120/240V split phase
Continuous AC power on Solar or Battery	9000W 37.5A L-L (240V) 4800W 40A L-N (120V)
Surge AC power 5sec	20,000VA L-L (240V) 10,000VA L-N (120V)
Frequency	60/50Hz
Continuous AC power with Grid or Generator	12000W 50A L-L (240V) 6000W 50A L-N (120V)
CEC Efficiency	96.5% (Peak 97.5%)
Idle Consumption typical – no load	60W
Sell back power modes	Limited to Household or Full Grid-Tied
Design (DC to AC)	Transformerless DC
Response Time (Grid-Tied to Off-Grid)	4ms
Power Factor	+0.9 - 1.0

Battery (optional)	
Type	Lead-Acid or Li-Ion
Nominal DC Input	48V
Capacity	90 – 2000Ah
Voltage Range	41.0 – 59.0V
Continuous Battery charging output	190A
Charging curve	3-stage w/ equalization
Grid to Battery Charging Efficiency	96.0%
External temperature sensor	included
Current shunt for accurate % SOC	integrated
External Generator Start based on voltage or % SOC	integrated
Communication to Lithium battery	CanBus & RS485

General	
Dimensions (H x W x D)	28.0" x 17.375" x 9.37"
Weight	75 lbs
Enclosure	NEMA type 1 (Indoor Use)
Ambient Temperature (4 variable speed fans)	-25 to 55C, >45C derating
Display	Color touch screen
Wi-Fi Communication (monitoring or SW updates)	integrated
Snap on sensors for limited selling to Household	included
Standard Warranty	5 years
Optional Extended Warranty	10 years

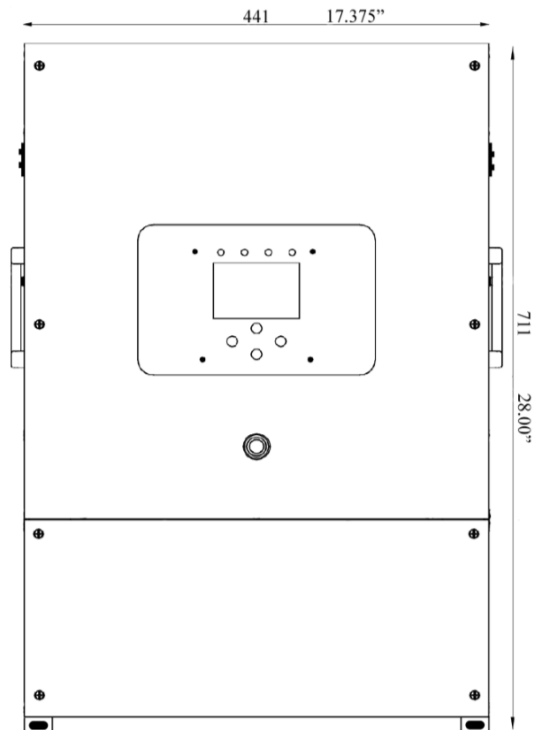
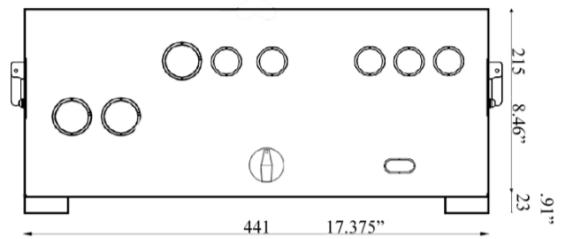

Protection & Certifications

Electronics certified safety by SGS labs to NEC & UL specs – NEC 690.4B & NEC 705.4/6	Yes
Grid Sell Back – UL1741-2010/2018, IEEE1547a-2003/2014, FCC 15 class B, (April 2019: UL1741SA, CA Rule 21, HECO Rule 14H)	Yes
PV DC disconnect switch – NEC 240.15	integrated
Ground Fault Detection – NEC 690.5	integrated
PV rapid shutdown control – NEC 690.12	integrated
PV Arc Fault detection – NEC 690.11/UL1699B	integrated
PV input lightning protection	integrated
AC input/output 50A breakers	integrated
Battery overcurrent fuse	integrated
User wiring enclosure w/ ¾" & 1" knock-outs	integrated
Solar Flare/EMP Hardened to 2015 MIL-STD-461G (Independently tested June 2018)	optional

Off-Grid Install Tips

- Limiter Sensors are not required for completely Off-Grid installs.
- The Grid input breaker on the Sol-Ark should be used as the Generator input (4-30kW generators) so that you maintain Smart Load output capability when off-grid. Smart Load will allow you to run high power non-essential appliances (hot water, dehumidifier, heat pump, irrigation pump) on solar power instead of batteries. Therefore, you will use Grid Charge (default) in the Battery Setup/Charge menu.
- When off grid there is no need for a transfer switch, simply connect the load output of the Sol-Ark to the whole home.
- Do not use Grid Sell or Limited To Home Modes. Only Limited power to load (default).
- The Auto Generator start functions as a 2-wire switch (closes the circuit when needing charging)
 - Auto Genstart will be triggered when the battery voltage or percent reaches the level programmed in the battery setup menu. Then once triggered the generator will continue to charge the batteries until they are about 95% full (this percentage is not programmable) before turning the generator off.

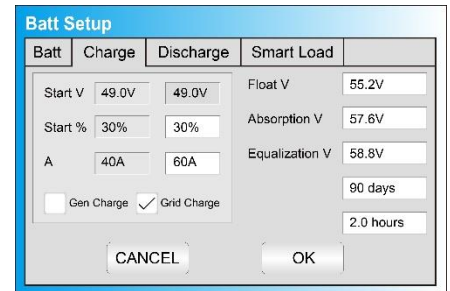
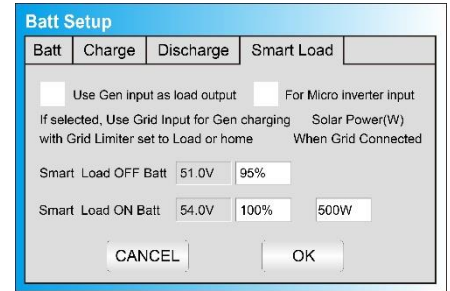

- Under setup for Grid/Sell Control, select General Standard and “GEN connect to Grid Input”. Then go to Grid/Gen input to widen the input frequency range to 53-65Hz to work with any frequency generator.
- If you are using a small portable generator, you may need to purchase an electrical filter from us to clean up the noisy power from the generator enough for the Sol-Ark to use it.
- If you would like to use a wind turbine in conjunction with Sol-Ark 8K, the turbine must have a 48V charge controller with a dump load as to prevent overcharging of the batteries. Simply connect the charge controller on the turbine to the battery bank the Sol-Ark is using and the turbine will help charge your batteries.
- Don't forget to set the Battery capacity and proper charge rates.

Grid-Tie / No Battery Install Tips

- Under Battery setup, select no Battery (or system will beep).
- Note: full system power cycle is required when changing between battery and no battery settings.
- Under Grid Setup, select Grid Sell.
- Touch Battery Icon to see the Detailed Volts View to verify your inputs & outputs.
- Note: If Rapid Shutdown is required, external 12V is required for transmitter when no batteries are used.

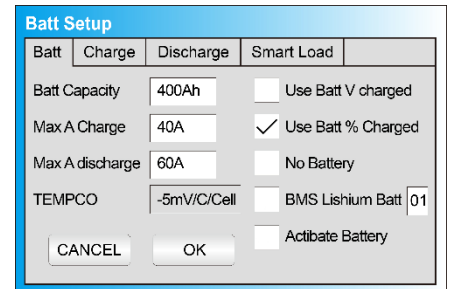

Solar	Grid	INV	Load	Batt
0W	0W 50.0Hz	0W 50.0Hz	0W	69W 87%
L1: 0V 0.0A 0W	117V HM: 0W LD: 0W	116V 0.2A 0W	116V 0W	51.13V 1.36A 0.0C
L2: 0V 0.0A 0W	117V HM: 0W LD: 0W	116V 0.2A 0W	116V 0W	DC:50.1C AC:40.3C

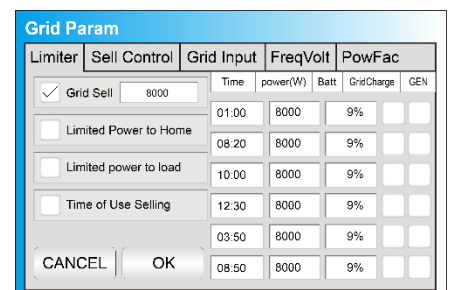

Powering on the system:

1. Make sure that Sol-Ark 8K is properly connected to the batteries, panels, grid, etc. (see system wiring diagram).
2. Turn on grid power breakers.
3. Press the power button on the front of the unit.
4. Make sure Solar panel inputs are not connected to Ground, then Turn on DC disconnect switch.
5. Turn on load breakers.

Indicator LEDs

- **DC**
 - Green = Solar Panels are producing
 - Off = Solar Panels are not producing
- **AC**
 - Green = Grid is Connected
 - Off = Grid is not Connected
- **Normal**
 - Green = Sol-Ark 8K is working properly
 - Off = Sol-Ark 8K is not working properly (call us)
- **Alarm**
 - Red = Alarm, check the alarms menu
 - Off = No alarms

Selecting your Power Mode:

Sol-Ark 8K will simultaneously use various power sources available in order to meet loads demand. The following power modes allow the user to determine the power sources available to Sol-Ark 8K.

- Limited Load / Self Consumption
 - Sol-Ark will only power loads connected to it. It will not produce more power than the connected loads require. This mode will neither sell back to the home nor grid.
- Limited To Home (zeroing home meter)
 - Pushes power to your whole home without selling back any excess to the grid (no net metering agreement required)
 - This mode requires the use of the limiter sensors
 1. Main Menu → System Settings → Grid Setup → Limiter → Limited to Home
 - Power source priority is same as Grid Sell Back
- Grid Sell Back
 - This Mode allows Sol-Ark 8K to sell back any excess power produced by the solar panels to the grid.
 - If home has a backup generator, this mode requires Limiter Sensors. See “Backup Generator Setup”
 1. Main Menu → System Settings → Grid Setup → Limiter → Grid Sell
 - Power source priority is as follows:
 1. Solar Panels
 2. Grid
 3. Generator
 4. Batteries (until programable % discharge is reached)
- Time Of Use (using batteries during peak power times)
 - Only available when using Limited To Home mode or Grid Sell Back modes
 - Use your batteries to reduce power consumption from the grid during a user programable peak pricing window of time.
 1. Main Menu → System Settings → Grid Setup → Limiter → Time Of Use

- Power source priority is as follows:
 1. Solar Panels
 2. Batteries (until programable % discharge is reached)
 3. Grid (can control when Grid charges)
- Off-Grid (powering loads)
 - This mode does not need to be programmed, Sol-Ark 8K will automatically operate in Off-Grid Mode in the absence of the grid.
 - Power source priority is as follows:
 1. Solar Panels
 2. Batteries
 3. Generator

Backup Generator Setup:

- Portable Generators (typically less than 10kW)
 - Connect to the generator output to the generator input breakers in the Sol-Ark 8K user panel.
 - Main Menu → System Settings → Battery Setup → Charge → Gen charge (only for Gen breakers)
- Standby Generators
 - Usually large generators have a whole home transfer switch that feeds the home. We suggest not using the generator input breakers in the Sol-Ark but your normal home wiring to distribute the Generator's power (through your existing Gen transfer switch).
 - If off grid, connect the output of the Generator directly to the Grid input on the Sol-Ark 8K. It can then treat the generator as if it were the grid.
 - Under setup for Grid/Sell Control, select General Standard and "GEN connect to Grid Input". Then go to Grid/Grid input to widen the input frequency range to 53-65Hz to work with any frequency generator.
 - Main Menu → System Settings → Battery Setup → Charge → Grid charge (only for Grid breakers)
- Auto Gen Start Signal
 - Automatically start compatible backup generators
 - The threshold at which gen charging is triggered can be set using the input boxes above the checkbox.
 - Main Menu → System Settings → Battery Setup → Charge → Gen or Grid charge (%Batt or V)

Sensors:

- Limiter Sensors (Current Sensors)
 - Placed on the grid side of your home breaker panel and are required to enable limited To Home mode (see diagrams).
- Battery Temperature Sensor
 - Placed on the battery bank and used to adjust charging voltage and capacity calculations
- PV Shutdown signal
 - Used to accommodate Rapid Shutdown of PV components and discharge onboard capacitors
- CanBus / RS485
 - Used to communicate with Lithium batteries

Batteries:

Supported Battery Chemistries (48V configuration required for all chemistries)

- Lead Acid
 - AGM, Gel, Wet
- Lithium
 - NMC, LiPo4
- NiFe (Note: must use a 37 series cell configuration, 44.4V Nominal)
 - Set Absorb and Equalization to 59.0V, 8 hours, and days = 1 (every day). Float = 53.7V

Programming Battery Settings

- f. Battery Size
 - i. This allows Sol-Ark to know the size of the battery bank
 - ii. Main Menu → System Settings → Battery Setup → Batt → Batt Capacity
- g. Battery Type
 - i. Navigate to the charge menu and set the values appropriate to your battery chemistry. The chart on page (15) is good reference for lead acid batteries.
 - ii. Main Menu → System Settings → Battery Setup → Charge
- h. Battery Discharge percentage
 - i. Allows the user to define the depth of discharge the system will allow before using the grid/generator to the charge the battery bank. Solar is always the first priority in charging the battery bank.
 - ii. Main Menu → System Settings → Battery Setup → Discharge

Limiter Sensor Automatic Setup

- 1) Install limiter sensors as described on page 25 (shown on page 11 as well). Battery and grid connections also required before starting auto-setup.
- 2) Navigate to the “Advanced” Tab of the Basic Setup screen (follow the directions below to get there).
 - a) Touch the gear icon → Touch the Basic Setup button → Select the Advanced tab (see Fig. G).
- 3) Select “Auto detect Home Limit Sensors” and press ok.
- 4) Wait for the Sol-Ark to finish its learning process (Sol-Ark will alternate sell back between legs and magnitude automatically determining the correct settings for the sensors).
- 5) Verify sensors were correctly configured (see Fig. H).

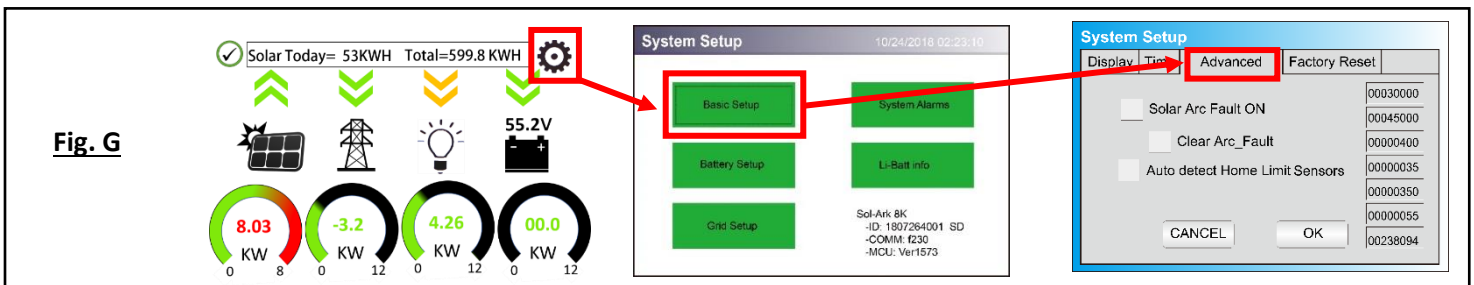

Fig. G

Fig. H

In Limited To Home Mode HM values will be close to zero. HM values should never be negative. If negative, the Limiter Sensors are not installed properly.

	Solar	Grid	INV	Load	Batt
	0W	0W 50.0Hz	0W 50.0Hz	0W	69W 87%
L1: 0V 0.0A		117V HM: 0W	116V 0.2A	116V	51.13V 1.36A
L2: 0V 0.0A		117V HM: 0W	116V 0.2A	116V	0.0C DC:50.1C
	0W	0W LD: 0W	0W	0W	AC:40.3C

Possible Limiter Sensor issues:

- Sensors are facing wrong direction
- Sensors are on the wrong wire(s)
- Sensors are not fully closed on wire(s)
- Sensor Polarity is wrong (White = + BLK = -)

Screens

- **Home Screen (Touchscreen)**

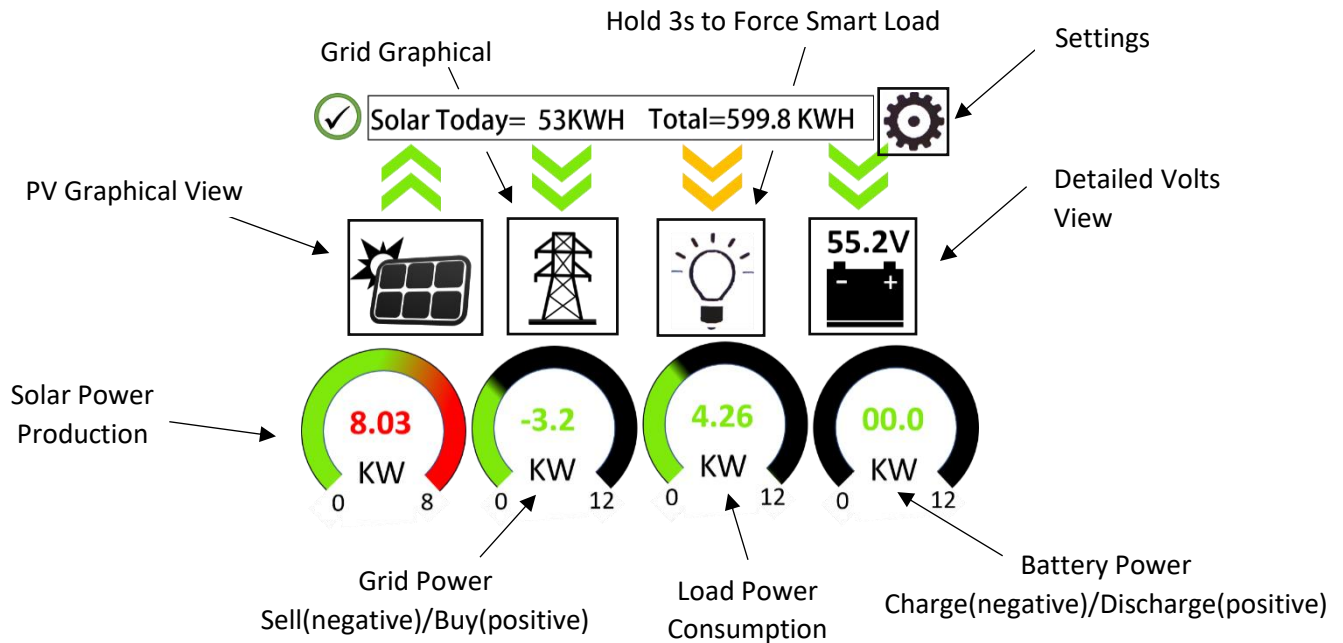

- **Detailed Volts View**

- Top row = Total power for column
- Middle Row = Line 1/PV1 voltage, Amps, and Watts (note: PV Voltage not to exceed 500)
- Bottom Row = Line 2/PV2 voltage, Amps, and Watts (note: PV Voltage not to exceed 500)
- Batt Temperature will show -20°C if temperature sensor is not connected.
- Batt SOC % = % batteries are charged
- DC Temp = Temperature of DC conversion electronics
 - Batt → AC
 - PV → Batt
 - AC → Batt
- AC Temp = Temperature of AC conversion electronics
 - Batt → AC
 - PV → AC
- Grid Column
 - If selling to grid, Grid Watts = negative
 - If buying from grid, Grid Watts = positive
 - Note: If these values are reversed, current sensors may have been installed incorrectly (reverse polarity).
 - HM = Power detected by the external current sensors on entire home L1 & L2
 - LD = Power detected using internal sensors on AC grid in/out breaker

- **PV Graphical View**
 - Displays power production over time for the PV array
 - Use up/down buttons to navigate between days
 - Month view, Year view, and Total view
- **Grid Graphical View**
 - Displays power drawn from and sold to the grid over time
 - Bars above the line indicate power bought from the grid
 - Bars below the line indicate power sold back to the grid
 - This view can be helpful in determining when the most power is used in the home and for time of use programming
- **System Setup Menu**
 - ID = LCD serial #. But we use the WIFI serial #.
 - COMM = LCD software version
 - MCU = Inverter software version
- **System Alarms**
 - Lists all system alarms
- **Basic Setup**
 - Display
 - Brightness adjustment
 - Auto dim (must be enabled for LCD screen to be covered by warranty)
 - Time
 - Set date and time for the system
 - Alarms & Safety
 - Arc fault detects if a poor connection in the PV wires
- **Batt Setup**
 - Batt
 - Batt Capacity: enter the size of the battery bank connected to the system
 - Max A charge: set the max charge rate for the batteries (This also sets PV → Battery charge rate)
 - Suggest 20%-30% of battery capacity for lead acid
 - Max A discharge: set max discharge for battery bank (this value will be ignored in off-grid mode to allow for constant power to loads)
 - TEMPCO: Temperature coefficient used in conjunction with the batt temp sensor to adjust optimal voltages for lead acid batteries
 - Use Batt V charged: displays battery charge in terms of voltage
 - Use Batt % charged: Battery voltage can be misleading for determining the % Charged. So, we use algorithms measuring power in and out to measure a true value for % Charged. It compensates for aging batteries also.
 - Charge
 - Float V: Set value appropriate for the batteries connected to the system using chart (Page 15/32)

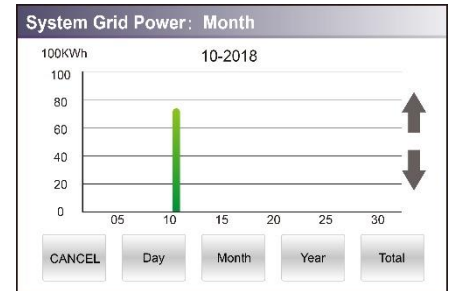
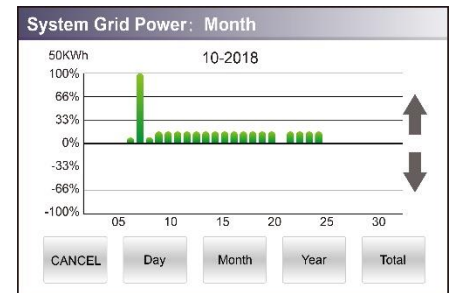

System Setup 10/24/2018 02:23:10

Basic Setup System Alarms

Battery Setup Li-Batt info

Grid Setup

Sol-Ark 8K
-ID: 1807264001 SD
-COMM: f230
-MCU: Ver1573

System Alarms 10/24/2018 01:54:21

Alarms Code	Occurred
F56 DC_VoltLow_Fault	2018-10-24 01:07
F56 DC_VoltLow_Fault	2018-10-24 01:07
F56 DC_VoltLow_Fault	2018-10-24 01:00
F56 DC_VoltLow_Fault	2018-10-24 00:55
F56 DC_VoltLow_Fault	2018-10-24 00:43
F56 DC_VoltLow_Fault	2018-10-24 00:10
F56 DC_VoltLow_Fault	2018-10-24 00:08
F56 DC_VoltLow_Fault	2018-10-24 00:07

System Setup

Display Time Alarms&Safety Factory Reset

Brightness

Beep

Auto Dim 600S

CANCEL OK

Batt Setup

Batt	Charge	Discharge	Smart Load
Batt Capacity	400Ah		<input type="checkbox"/> Use Batt V charged
Max A Charge	40A		<input checked="" type="checkbox"/> Use Batt % Charged
Max A discharge	60A		<input type="checkbox"/> No Battery
TEMPCO	-5mV/C/Cell		<input type="checkbox"/> BMS Lishium Batt 01
			<input type="checkbox"/> Actibate Battery

CANCEL OK

- Absorption: Set value appropriate for the batteries connected to the system using chart (Page 15)

- Absorption will stop at 1% of the capacity of the battery bank and drop to float
- Ex: 400Ah battery would be 4A

- Equalization: Set value appropriate for the batteries connected to the system using chart (Page 15)

- Days: period of time between equalization cycles

- Hours: period of time taken to equalize batteries

- Note if Hours = 0 system will not equalize the batteries

- Gen Charge: uses the gen input of the system to charge battery bank from an attached generator.

- Start V: voltage at which system will AutoStart a connected generator to charge the battery bank
- Start percentage: Percent S.O.C at which system will AutoStart a connected generator to charge the battery bank
- A: charge rate from the attached generator in Amps
 - Note: size this value appropriately for your given generator size

- Grid Charge

- Start V: voltage at which system will charge the battery bank from the grid. If grid is on, batteries will stay at float voltage.
- Start percentage: Percent S.O.C at which system will AutoStart a connected generator to charge the battery bank
- A: charge rate from the grid in Amps

- **Discharge**

- Shutdown V: battery voltage at which the inverter will shut down (batt symbol on home screen will turn red)
- Low Batt: Low battery voltage (batt symbol on home screen will turn yellow)
- Restart: battery voltage at which AC output will resume
- Batt Resistance: used in % SOC batt calculations
- Batt Charge Efficiency: used in % SOC batt calculations

- **Smart Load (Gen Load)**

- This mode utilizes the Gen input connection as an output which only receives power when the battery is above a user programmable threshold.
- The Gen input breaker in the user area of the system becomes an output to high power loads such as a water heater, irrigation pump, ac unit, pool pump.
- Smart Load OFF Batt
 - Battery voltage at which the Gen load will stop being powered
- Smart Load ON Batt
 - Battery voltage at which the gen load will start being powered
- Note: If using Gen load for a water heater, it is recommended that only one leg (120V) be connected to the bottom element. This significantly reduces the power consumption of the water heater while retaining core functionality (it will heat water, only slower).
- Note: Gen Load is limited to 40A at 240V (Do not exceed!)

- Solar Watts is for on grid.
 - System waits to turn on smart load until sufficient PV power is produced (when on grid).
- **AC Coupling Settings (For Micro Inverter Input)**
 - To use the Grid input breaker as a micro inverter AC coupled input, check the “For Micro inverter Input” box (this feature will also work with “Grid-Tied” Inverters)

- 13kW = Maximum combined input to Sol-Ark (AC+DC)
 - Best: 3kWAC + 10kWDC
 - Good: 4kWAC + 9kWDC
 - OK: 2kWAC + 11kWDC
 - OK: 5kWAC + 8kWDC
 - OK: 6kWAC + 7kWDC
 - OK: 7kWAC + 6kWDC

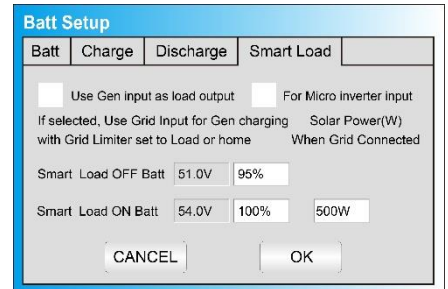

- **Grid Setup**

- Limiter

- Grid Sell: maximum watts sold to grid
- Limited To Home: Limits power produced by the system to match the demand of the home
- Limited To Load: Limits power produced by the system to match the demand of connected loads
- Time Of Use:
 - Time: When the system will sell batt/PV power to the grid or home
 - Power(W): Max watts to be sold from the battery at each time
 - Batt: The battery voltage or % at which the system will limit selling to the grid or home from the battery. The system will drain the battery until that percent/voltage is reached.
 - Charge: Enables grid charging during a selected period. PV will always charge to 100%.
 - For Examples: See Page 37
- Note: This mode requires Grid sell / limited to home be enabled.
- Note: If you need the batteries to never charge from the grid, uncheck the “Grid Charge” box under the charge tab of the battery menu (see page 29).

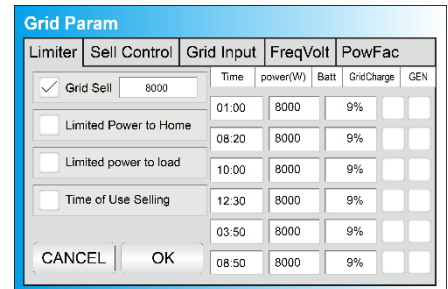

- Sell Control

- General Standard: uses Protect Parameters in table
- UL 1741 & IEEE1547: Enables sell compliant functionality
- UL1741SA: Enables wider Freq, Voltage, and PowerFactor
- GEN connect to Grid Input: Must be set if Generator is connected to AC Grid breaker

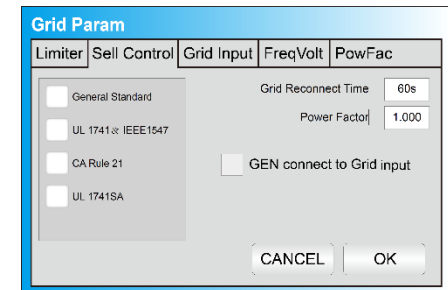

- Grid Input

- Grid Frequency: Select the frequency of the grid connected to the system
- Grid Type:
 - 220V Single Phase (Call us before using)

- 120/240 Split Phase (North America)
- 120/208V 3 Phase
- Note: If 120/208V, the L1 and L2 are phase specific. So, you may have to swap Grid L1 L2 for 208V applications.
- Note: Inverter power cycle is required each time the input/output voltage is changed

- Protect Parameters (when
 - Settings when the system will connect/disconnect from grid
 - This is not used when UL 1741 & IEEE1547 is enabled
 - You may need to widen the frequency range when using a generator (53-65 Hz)

○ **FreqVolt**

- **Puerto Rico Grid Compliance Settings (UL 1741SA must be enabled in “Sell Control” tab):**

- **Kauai Grid Compliance Settings (UL 1741SA must be enabled in “Sell Control” tab):**

○ **PowFac**

- Power Factor is programmable from 0.9 – 1.0.

Battery Charging Information

4-Stage Charging

The MPPT has a 4-stage battery charging algorithm for rapid, efficient, and safe battery charging. The figure below shows the stage sequence.

MPPT Charging Algorithm

Bulk Charge Stage

In Bulk Charge stage, the battery is not at 100% state of charge and battery voltage has not yet charged to the Absorption voltage setpoint. The controller will deliver 100% of available solar power to recharge the battery.

Absorption Stage

When the battery has recharged the absorption voltage setpoint, constant-voltage regulation is used to maintain battery voltage at the absorption setpoint. This prevents heating and excessive battery gassing. The battery is allowed to come to full state of charge at the absorption voltage setpoint. Absorption lasts until batteries charge at 2% of programmed Ah size.

Float Stage

After the battery is fully charged in the Absorption stage, the MPPT reduces the battery voltage to the float voltage setpoint. When the battery is fully recharged, there can be no more chemical reactions and all the charging current is turned into heat and gassing. The float stage provides a very low rate of maintenance charging while reducing the heating and gassing of a fully charged battery. The purpose of float is to protect the battery from long-term overcharge.

Battery Charging Setpoint (48V)

Battery Type	Absorption Stage	Float Stage	Equalize Stage (every 90 days 3hr)
AGM (or PCC)	14.2v (56.8v)	13.4v (53.6v)	14.2v (56.8v)
Gel	14.1v (56.4v)	13.5v (54.0v)	
Wet	14.7v (59.0v)	13.7v (55.0v)	14.7v (59.0v)
Lithium	14.1v (58.0v)	13.2v (56.0v)	

Default

Note:

When batteries are in series, the voltages add to each other.

When batteries are in parallel the Amp hours add to each other.

How to calculate Amp Hours for your battery bank (PCC 230):

Battery Count	Voltage per Battery	Amp Hours per Battery	Total Amp Hours @48V	Max Charge/Discharge Amp
4	12V	230Ah	230Ah	100A
8	12V	230Ah	460Ah	185A
12	12V	230Ah	690Ah	185A
16	12V	230Ah	920Ah	185A

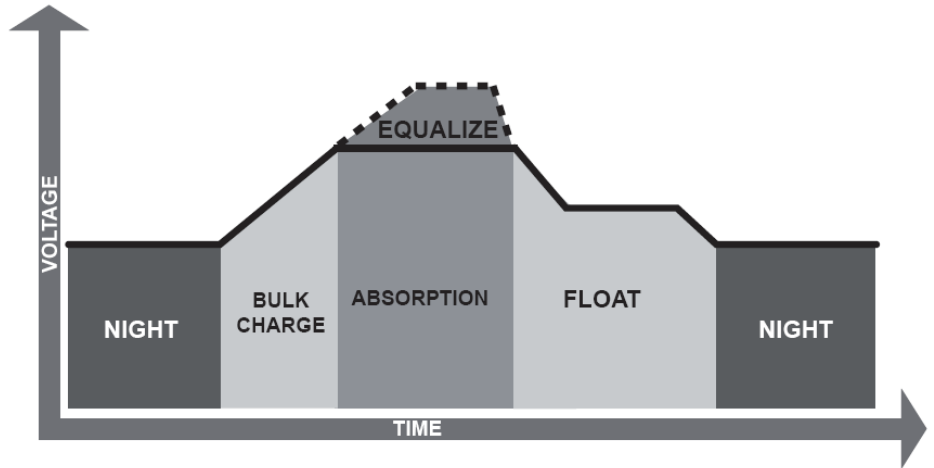

Warranty: Sol-Ark 8K Hybrid Inverter

5-Year Limited Warranty for SOL-ARK (Portable Solar LLC) Products. Sol-Ark provides a Five-year (5) limited warranty (“Warranty”) against defects in materials and workmanship for its Sol-Ark products (“Product”). The term of this Warranty begins on the Product(s) initial purchase date, or the date of receipt of the Product(s) by the end user, whichever is later. This must be indicated on the invoice, bill of sale from your installer. This Warranty applies to the original Sol-Ark Product purchaser and is transferable only if the Product remains installed in the original use location. Please call Sol-Ark to let us know if you are selling your home and give us name and contact of the new owner.

10 Year Extended warranty if purchased bares same rules, except for the Time the warranty is in effect; which will be 10 years from date of purchase or the date of receipt of the Product(s) by the end user, whichever is later.

The warranty does not apply to any Product or Product part that has been modified or damaged by the following:

- ❖ Installation or Removal (examples: wrong voltage batteries, connecting batteries backwards, damage due to water/rain to electronics, preventable damage to solar wires.)
- ❖ Alteration or Disassembly
- ❖ Normal Wear and Tear
- ❖ Accident or Abuse
- ❖ Unauthorized Firmware updates/software updates or alterations to the software code
- ❖ Corrosion
- ❖ Lightning; unless using EMP hardened system, then Portable Solar will repair product
- ❖ Repair or service provided by an unauthorized repair facility
- ❖ Operation or installation contrary to manufacturer product instructions
- ❖ Fire, Floods or Acts of Nature
- ❖ Shipping or Transportation
- ❖ Incidental or consequential damage caused by other components of the power system
- ❖ Any product whose serial number has been altered, defaced or removed
- ❖ Any other event not foreseeable by Portable Solar, LLC

Sol-Ark (Portable Solar LLC) liability for any defective Product, or any Product part, shall be limited to the repair or replacement of the Product, at Portable Solar LLC discretion. Sol-Ark does not warrant or guarantee workmanship performed by any person or firm installing its Products. This Warranty does not cover the costs of installation, removal, shipping (except as described below), or reinstallation of Products or parts of Products.

THIS LIMITED WARRANTY IS THE EXCLUSIVE WARRANTY APPLICABLE TO SOL-ARK (PORTABLE SOLAR LLC) PRODUCTS. SOL-ARK EXPRESSLY DISCLAIMS ANY OTHER EXPRESS OR IMPLIED WARRANTIES OF ITS PRODUCTS. SOL-ARK ALSO EXPRESSLY LIMITS ITS LIABILITY IN THE EVENT OF A PRODUCT DEFECT TO REPAIR OR REPLACEMENT IN ACCORDANCE WITH THE TERMS OF THIS LIMITED WARRANTY AND EXCLUDES ALL LIABILITY FOR INCIDENTAL OR CONSEQUENTIAL DAMAGES, INCLUDING WITHOUT LIMITATION ANY LIABILITY FOR PRODUCTS NOT BEING AVAILABLE FOR USE OR LOST REVENUES OR PROFITS, EVEN IF IT IS MADE AWARE OF SUCH POTENTIAL DAMAGES.

Return Policy - No returns will be accepted without prior authorization and must include the Return Material Authorization (RMA) number. Please call and talk to one of our engineers to obtain this number at 972-575-8875.

Any product that is returned must be brand new, in excellent condition and packaged in the original manufacturer's carton with all corresponding hardware and documentation. Returns must be shipped with prepaid freight and insured via the carrier of your choice to arrive back at Portable Solar within 30 days of your initial delivery or pick-up. **Shipping charges will not be refunded.**

All returns are subject to a 35% restocking fee. **No returns will be accepted beyond 30 days of original delivery.** The value and cost of replacing any items missing (e.g. parts, manuals, etc.) will be deducted from the refund. If you have any questions regarding our return policy, please email us at sales@sol-ark.com or call us at the number above during regular (M-F) business hours.

Sol-Ark 8K Install Operational Verification Checklist Questionnaire must be filled out, signed, and dated to secure full warranty coverage.

Troubleshooting Guide

- **LCD is not powering on**
 - Check all connections
 - At least one of the following power sources is required: PV/Grid/Battery
 - Try pressing the power button. Or touchscreen or navigation button.
- **Panels are connected but DC Light is not on**
 - PV voltage must be 150V-500V
 - It's night
- **Panels are not producing**
 - Check all solar panel connections are wired properly
 - Turn on PV disconnect
 - Check that the PV input voltage is not greater than 500V
 - If system says PV=0V, check PV polarity
- **Panels are not producing much power**
 - PV Wire Strip Length: 5/8". Try setting system to Grid Sell.
- **System not keeping batteries charged**
 - Check the charge setting in the Charge Menu
- **Auto Gen-Start not working**
 - Check to make sure your generator is compatible with Auto Start
 - Make sure that the Auto Gen Start wire is connected properly to the Sol-Ark 8K and the generator
- **Normal LED isn't on**
 - Sol-Ark 8K is not working properly (Call us)
- **Alarm Light is on**
 - Check the system alarms menu to see which alarm has been triggered
- **Grid HM value is negative when it should be positive (only applies in limited home mode)**
 - Limiter Sensors are installed backwards or L1/L2 sensors are swapped or L1/L2 sensors mis-wired
- **AC Overload Fault or Bus Unbalance Fault**
 - Check Transfer Switch/Subpanel wiring
 - Check for large loads that pull more than the inverter is rated for (EX: AC units over 4 tons)
- **System connects to grid and quickly disconnects**
 - With a DMM, verify your Neutral wire is connected (should be 0Vac referenced to GND)
 - Check your Freq is set to 60Hz and the 8K see's 120V on L1 & L2 to N.
 - If overloading: verify 120/240V grid input and load output wires are not swapped.
 - If 120/208V, the L1 and L2 are phase specific. So, you may have to swap Grid L1 L2 for 208V applications.
- **DC Overload Fault**
 - Check PV voltage
 - Make sure you have not wired more than 2 solar stings in parallel
- **System is beeping**
 - Check the system alarms menu to see which alarm has been triggered. Most alarms will self-reset.
 - There is no battery connected. If not using a battery, select no battery in the setup Batt menu.
 - To fully reset system, turn off center button, remove AC Grid and PV Power for 30s (screen is dead), then power up.
- **Battery cable is sparking when connected**
 - Use included resistor to connect the batteries (for the first time) to charge inverter capacitors before fully connecting to batteries (see installation guide)
- **Battery symbol on home screen is red**
 - Battery is under voltage or over voltage

- **Battery symbol on home screen is yellow**
 - Battery is low or charge/discharge current is close to the programmed limit (which is ok)
- **Grid symbol on home screen is yellow**
 - Grid parameters are out of specified range or grid is down
- **System has restarted**
 - Happens if: System is overloaded, Battery voltage is greater than 61V, or Software update
- **Batteries were connected backwards**
 - Battery fuse has blown (Call us)
- **Why is LCD screen still on when power button is off?**
 - If PV or Grid power, LCD stays on but inverter and loads are off.
- **The Batt % meter is not reaching 100%**
 - System needs to go through a small discharge/charge cycle to first calibrate battery
- **Generator setup is reading 0Hz**
 - Select “General Standard” instead of UL1741. Then widen the voltage range to 53Hz-65Hz.
- **Color Touchscreen is Frozen**
 - Press and hold the escape button [←] for 7-10 seconds

Sol-Ark 8K Error Codes

Fault information	Instruction	Common Cause/Remedy
F01	DC_Inversed_Failure	Battery Input Polarity is reversed, Turn off system & correct
F02	DC_Insulation_Failure	Check DC wiring for damage to the insulation
F03	GFDI_Failure	Ground Fault, check wiring
F04	GFDI_Ground_Failure	Ground Fault, check wiring
F05	EEPROM_Read_Failure	Contact Sol-Ark.com
F06	EEPROM_Write_Failure	Contact Sol-Ark.com
F07	GFDI_Fuse_Failure	Ground fault, check wiring
F08	GFDI_Relay_Failure	Contact Sol-Ark.com
F09	IGBT_Failure	Contact Sol-Ark.com
F10	AuxPowerBoard_Failure	Contact Sol-Ark.com
F11	AC_MainContactor_Failure	Contact Sol-Ark.com
F12	AC_SlaveContactor_Failure	Contact Sol-Ark.com
F13	Working_Mode_change	Can happen when not using batteries
F14	DC_OverCurr_Failure	Usually caused by Loads that are too large (ex: 5 Ton AC Unit)
F15	AC_OverCurr_Failure	Usually caused by Appliances that are too large
F16	GFCI_Failure	Ground fault, check wiring
F17	Tz_COM_OC_Fault	Contact Sol-Ark.com
F18	Tz_Ac_OverCurr_Fault	Overloaded the Load Output, reduce loads. Wiring Short on the AC Side can also cause this error.
F19	Tz_Integ_Fault	Contact Sol-Ark.com
F20	Tz_Dc_OverCurr_Fault	Usually caused by Loads that are too large (ex: 5 Ton AC Unit)
F21	Tz_GFDI_OC_Fault	Contact Sol-Ark.com
F22	Tz_EmergStop_Fault	Contact Sol-Ark.com
F23	Tz_GFCI_OC_Fault	Contact Sol-Ark.com
F24	DC_Insulation_Fault	Contact Sol-Ark.com

F25	DC_Feedback_Fault	Contact Sol-Ark.com
F26	BusUnbalance_Fault	Too much load one leg (L1 or L2) Vs the other leg
F27	DC_Insulation_ISO_Fault	Contact Sol-Ark.com
F28	DCIOver_M1_Fault	Contact Sol-Ark.com
F29	AC_AirSwitch_Fault	Contact Sol-Ark.com
F30	AC_MainContactor_Fault	Contact Sol-Ark.com
F31	AC_SlaveContactor_Fault	Contact Sol-Ark.com
F32	DCIOver_M2_Fault	Contact Sol-Ark.com
F33	AC_OverCurr_Fault	Usually caused by Loads that are too large
F34	AC_Overload_Fault	Usually caused by Loads that are too large
F35	AC_NoUtility_Fault	Contact Sol-Ark.com
F36	AC_GridPhaseSeque_Fault	Contact Sol-Ark.com
F37	AC_Volt_Unbalance_Fault	Contact Sol-Ark.com
F38	AC_Curr_Unbalance_Fault	Contact Sol-Ark.com
F39	INT_AC_OverCurr_Fault	Contact Sol-Ark.com
F40	INT_DC_OverCurr_Fault	Contact Sol-Ark.com
F41	AC_WU_OverVolt_Fault	Contact Sol-Ark.com
F42	AC_WU_UnderVolt_Fault	Contact Sol-Ark.com
F43	AC_VW_OverVolt_Fault	Contact Sol-Ark.com
F44	AC_VW_UnderVolt_Fault	Contact Sol-Ark.com
F45	AC_UV_OverVolt_Fault	Contact Sol-Ark.com
F46	AC_UV_UnderVolt_Fault	No Battery and PV Disconnect is Turned OFF
F47	AC_OverFreq_Fault	Contact Sol-Ark.com
F48	AC_UnderFreq_Fault	Contact Sol-Ark.com
F49	AC_U_GridCurr_DcHigh_Fault	Contact Sol-Ark.com
F50	AC_V_GridCurr_DcHigh_Fault	Contact Sol-Ark.com
F51	AC_W_GridCurr_DcHigh_Fault	Contact Sol-Ark.com
F52	AC_A_InductCurr_DcHigh_Fault	Contact Sol-Ark.com
F53	AC_B_InductCurr_DcHigh_Fault	Contact Sol-Ark.com
F54	AC_C_InductCurr_DcHigh_Fault	Contact Sol-Ark.com
F55	DC_VoltHigh_Fault	Check battery voltage, should not be above 59V
F56	DC_VoltLow_Fault	Batteries are overly discharged
F57	AC_BackFeed_Fault	Contact Sol-Ark.com
F58	AC_U_GridCurr_High_Fault	Contact Sol-Ark.com
F59	AC_V_GridCurr_High_Fault	Contact Sol-Ark.com
F60	AC_W_GridCurr_High_Fault	Contact Sol-Ark.com
F61	AC_A_InductCurr_High_Fault	Contact Sol-Ark.com
F62	AC_B_InductCurr_High_Fault	Contact Sol-Ark.com
F63	ARC_Fault	Can be a false alarm or bad PV connection
F64	Heatsink_HighTemp_Fault	Check the built-in fans, ambient temp may be to high

Common Battery Application Notes

Sol-Ark PCC-230 Battery

Batt Capacity: 230Ah x #Parallel_Batteries
 (1 parallel = 4 Batt in series, 2 = 8 Batt, 3 = 12 Batt, 4 =16 Batt)
 Max A Charge: 100A x #Parallel_Batteries
 Max A Discharge: 100A x #Parallel_Batteries
 Max A Grid Charge: 50A x #Parallel_Batteries
 TEMPCO: -5mV/C/Cell
 Float V: 53.6V
 Absorption V: 56.8V
 Equalization V: 56.8V
 Equalization Days: 90
 Equalization Duration: 3 Hours
 Recommended Shutdown V / Percentage: 41.0V & 20%
 Recommended Low Batt V / Percentage: 45.0V & 35%
 Recommended Restart V / Percentage: 52.0V & 50%
 Battery Resistance: 6mOhms (8 Batt) or 3mOhms (16 Batt)
 Battery Charge Efficiency: 99%

Time	Watts	SOC	GridCharge
1:00AM	1500*Par_Batts	50%	
5:00AM	1500*Par_Batts	50%	
9:00AM	1500*Par_Batts	50%	
1:00PM	1500*Par_Batts	100%	
4:00PM	1500*Par_Batts	50%	
9:00PM	1500*Par_Batts	50%	

These settings will charge the batteries off solar only.
 Discharge the batteries down to a maximum of 50% full.

Limited To Home mode will not sell to the grid from the batteries (only the home will use battery power). The 100% time slot is to ensure that the batteries are properly cycled each day.

Generation 2 Fortress Battery-eVault16.5

Batt Capacity: 360Ah x #Parallel_Batteries
 Max A Charge: 150A (100A for life) x #Parallel_Batteries
 Max A Discharge: 160A x #Parallel_Batteries
 Max A Grid Charge: 100A x #Parallel_Batteries
 TEMPCO: 0mV/C/Cell
 BMS Lithium Batt: Not Selected
 Float V: 54.4V
 Absorption V: 54.6V
 Equalization V: 56V
 Equalization Days: 30
 Equalization Duration: 1 Hours (tops off battery)
 Recommended Shutdown V / Percentage: 51.3V & 20%
 Recommended Low Batt V / Percentage: 51.7V & 30%
 Recommended Restart V / Percentage: 51.9V & 40%
 Battery Resistance: 5mOhms
 Battery Charge Efficiency: 99%

Time	Watts	SOC	GridCharge
1:00AM	6000*Par_Batts	40%	
5:00AM	6000*Par_Batts	40%	
9:00AM	6000*Par_Batts	40%	
1:00PM	6000*Par_Batts	40%	
5:00PM	6000*Par_Batts	40%	
9:00PM	6000*Par_Batts	40%	

These settings will charge the batteries off solar only.
 Discharge the batteries down to a maximum of 40% full.

Limited To Home mode will not sell to the grid from the batteries (only the home will use battery power).

Simplifi Power: PHI 3.5 Battery 48V

Batt Capacity: 69Ah x # Batt
 Max A Charge: 34A x # Batt (20A for better lifespan)
 Max A Discharge: 60A x # Batt (34A for better lifespan)
 Max A Grid Charge: 20A x # Batt
 TEMPCO: 0mV/C/Cell
 BMS Lithium Batt: Not Selected
 Float V: 49.5V
 Absorption V: 54.4V
 Equalization V: 56V
 Equalization Days: 30
 Equalization Duration: 1 Hours (tops off battery)
 Recommended Shutdown V / Percentage: 50.2V & 20%
 Recommended Low Batt V / Percentage: 50.6V & 30%
 Recommended Restart V / Percentage: 51.0V & 40%
 Battery Resistance: 8mOhms
 Battery Charge Efficiency: 98%

Time	Watts	SOC	GridCharge
1:00AM	1000*Batts	40%	
5:00AM	1000*Batts	40%	
9:00AM	1000*Batts	40%	
1:00PM	1000*Batts	40%	
5:00PM	1000*Batts	40%	
9:00PM	1000*Batts	40%	

These settings will charge the batteries off solar only.
 Discharge the batteries down to a maximum of 40% full.

Limited To Home mode will not sell to the grid from the batteries (only the home will use battery power).

Wire Gauge Guide

PV input: 10AWG

Grid input: 6-4AWG

Gen input: 6-4AWG

Load output: 6-4AWG

All Sensors: 20-24AWG

Battery input: 2/0-4/0AWG (3/8th Lugs)

15.875mm (5/8in)

23.813mm (15/16in)

Limiter
Sensor
Small

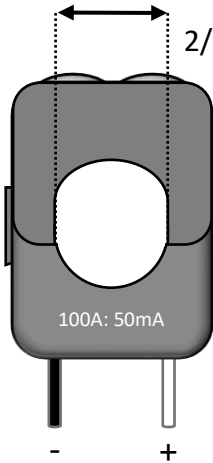

Limiter
Sensor
Large

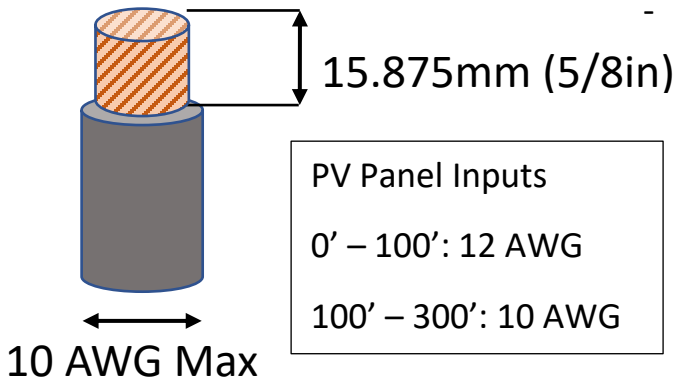
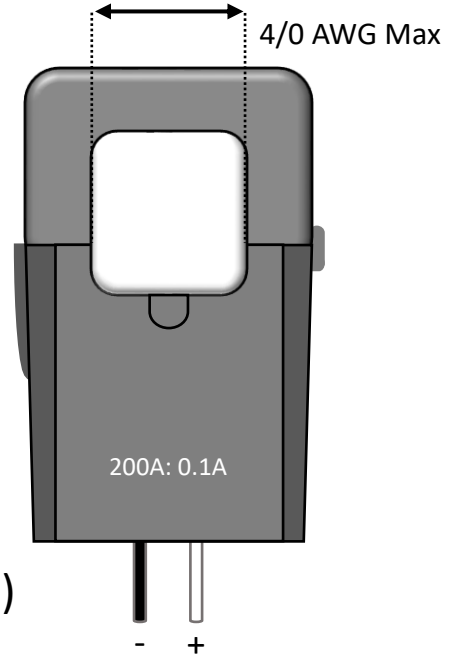

25.4mm (1.0in)

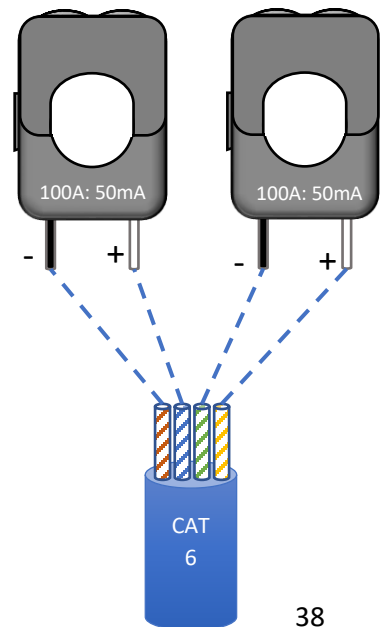
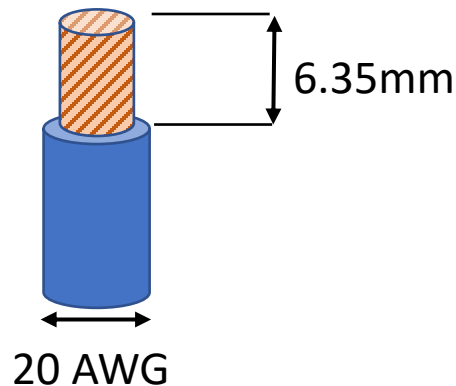
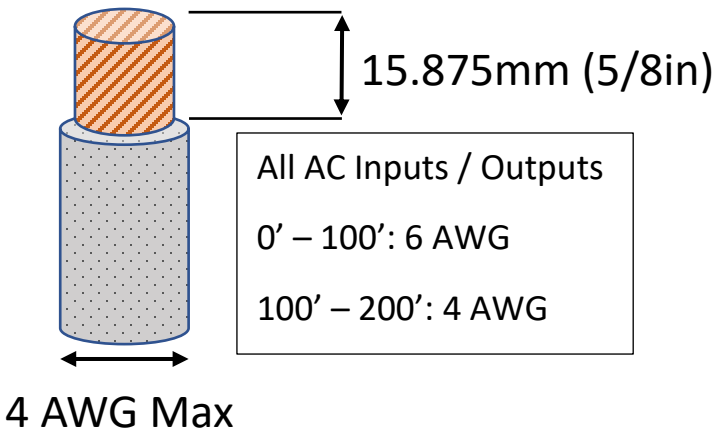
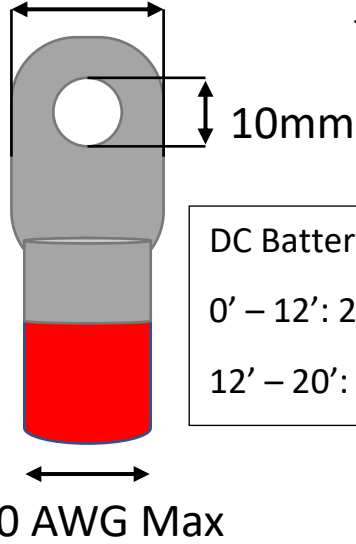

Sol-Ark 8K Install Operational Verification Checklist Questionnaire

For installer to complete after system is operational. Purpose is to protect installer, homeowner, and inverter.

1. Is the 8K installed in a location protected from water and has 6" clearance left and right for cooling? **Y/N**
2. Are all the battery lugs tightened? **Y/N**
3. 8K should be connected to Grid, 8K 50A load/Grid breakers on, batteries connected, PV input on and ON button on. Leaving all 10 transfer switches on Line/Grid, test circuit only one at a time to Gen/Solar and then back to Line. Wiring should be correct if you do all 10 to verify no breakers pop or inverter overload.
 - a. Did any breakers trip? **Y/N**
 - b. Did inverter overload? **Y/N**
 - c. Set all switches to Gen/Solar.

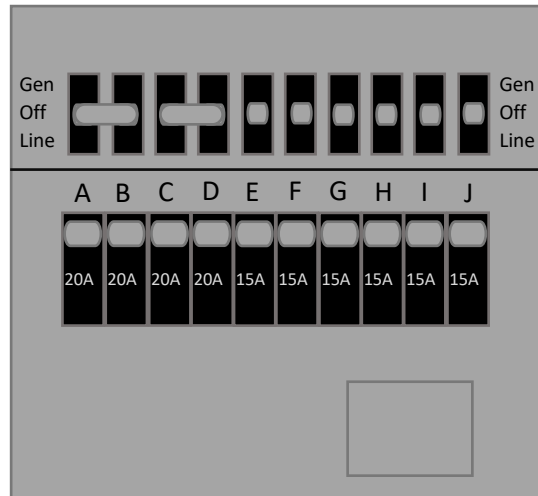

4. If you have problems, please take pictures of these and email to: sales@Sol-Ark.com
 - a. **Battery icon screen, showing detailed voltages (the screen shown below)**
 - b. **Sol-Ark 8K with batteries and of user wiring area**
5. Load and solar test
 - a. Did you do this entire section with the customer to explain the home screen and the detailed voltages screen? **Y/N**
 - b. Press the battery icon for the detailed voltages screen.
 - c. Is batt temp sensor working? **Y/N**
 - d. Turn on many loads for the critical circuits. Are solar panels producing enough power to match the load (provided there is enough sun)? **Y/N**
 - e. **Verify** screen in limited power to loads mode (default). Are both Grid Home measurements positive? **Y/N**
 - f. Program Full Grid sell mode. If there are enough panels and sun or light loads in the entire house, the Grid HM measurements will be negative on both L1/L2. Are they negative (solar selling back to grid)? **Y/N**
 - g. Program limited power to home mode. The Grid HM sensors will be near zero or slightly positive. Are they both near zero and cancelling out the whole home power? **Y/N**
 - h. You have verified the limit sensors are correctly installed. If MCU Software is 1664 or higher, an auto learn function corrects any mistakes in limiter wiring. Program in the correct Grid mode the customer will use.
6. Did you program the correct Ah for battery bank and ~20% max Amps charge/discharge? **Y/N**
7. Did you program the correct battery charge voltages for your battery type? **Y/N**
8. Turn off the AC breaker so 8K is operating in off grid mode for several minutes. Are appliances still powered? **Y/N**
9. Turn off PV input, running only on batteries for several minutes. Are appliances still powered? **Y/N**

In Limited To Home Mode HM values will be close to zero. HM values should never be negative. If negative, the Limiter Sensors are not installed properly.

Solar	Grid	INV	Load	Batt
0W	0W 50.0Hz	0W 50.0Hz	0W	69W 87%
L1: 0V 0.0A	117V HM: 0W	116V 0.2A	116V	51.13V 1.36A
0W	LD: 0W	0W	0W	0.0C
L2: 0V 0.0A	117V HM: 0W	116V 0.2A	116V	DC:50.1C AC:40.3C
0W	LD: 0W	0W	0W	

10. Turn on PV input and AC Grid inputs.
11. Did you setup Wi-Fi plug to the customer's internet? **Y/N**
12. Absolutely important for software updates. Did you help customer register system on Monitoring App? **Y/N**
13. Does customer have a standby generator or small portable generator? **Y/N**
 - a. Did you turn off UL1741/IEEE1547 (use General Standard) and reprogram grid freq range to 53-65Hz? **Y/N**
 - b. If standby generator, are the current limit sensors on the Grid side of the generator transfer switch? **Y/N**
 - c. If small gas generator using Gen inputs, did you enable Gen charging and properly set charge current? **Y/N**
14. If EMP protected, did you install EMP Suppressors on critical appliance cords? **Y/N**

Installer Name

Installer Signature

Date

Customer Name

Customer Signature

Date